



# HPM6000

## Hydraulic data logger

### User manual





**Foreword**

**Revisions**

<b>Version</b>	<b>Date</b>	<b>Change</b>
1.0	12/2009	First edition

## Content



<b>Foreword</b>	<b>3</b>
Revisions	3
<b>1. Safety Notes/Range of Products</b>	<b>6</b>
1.1 Proper and intended usage	6
1.2 Qualified personnel	6
1.3 Accuracy of the technical documentation	6
1.4 High pressure applications	7
1.5 Service and repair	7
1.6 Notes on disposal	8
<b>2. Device version/Scope of delivery/Updates</b>	<b>9</b>
2.1 Updates – Updating the instrument firmware	10
<b>3. Instrument description</b>	<b>11</b>
3.1 Ports on the base instrument	13
3.2 Input module connections	14
<b>4. Connecting inputs and outputs</b>	<b>15</b>
4.1 CAN-bus sensors	15
4.2 Digital IN/OUT	17
4.3 Analogue sensors with automatic sensor-ID	18
4.4 Sensors without sensor-ID	19
<b>5. Power supply</b>	<b>20</b>
5.1 Charging the battery / battery status indicator	20
5.2 Changing the battery	20
<b>6. Menu Navigation Basics</b>	<b>21</b>
6.1 Keys and functions	21
6.2 Screen layout	22
6.3 Symbols and navigating the menus	24
6.4 Quick navigation	31
<b>7. Quick-start measurements</b>	<b>32</b>
7.1 Start/stop measurements	32
7.2 Changing the display	33
7.3 Monitoring measurements	34
7.4 Ending the measurements	35

<b>8.</b>	<b>Menu Options</b>	<b>36</b>
8.1	Main menu	38
8.2	F1 - EDIT menu	56
8.3	F2 - VIEW menu	61
8.4	F3 - RESET menu	82
8.5	F4 - REC menu	86
<b>9.</b>	<b>Operations</b>	<b>93</b>
9.1	Basic settings and network connection	93
9.2	Measurement memory settings	97
9.3	Sensor settings and information	99
9.4	Executing and saving measurements	103
9.5	Creating and loading projects	113
9.6	Loading and analyzing saved measurements	116
<b>10</b>	<b>Measurement Types and Memory Options</b>	<b>120</b>
10.1	An explanation of measurement types	120
10.2	Notes on triggered and trigger-logic measurements	121
10.3	Memory options	125
<b>11.</b>	<b>Maintenance and cleaning</b>	<b>129</b>
11.1	Notes on cleaning	129
11.2	Notes on maintenance and calibration	129
11.3	Repairs	129
<b>12.</b>	<b>Accessories</b>	<b>130</b>
12.1	General accessories	130
12.2	Analogue sensors (with automatic sensor-ID) and connecting cable	130
12.3	CAN-bus sensors (with automatic sensor-ID) and connecting cable	131
<b>13.</b>	<b>Technical Specifications</b>	<b>132</b>
13.1	Base instrument and options	132
13.2	Base instrument - inputs	133
13.3	Interfaces on base instrument	134
13.4	Basic instrument - additional components	136
13.5	Input module, model 01	139

### 1. Safety Notes/Range of Products

#### 1.1 Proper and intended usage

This measuring instrument ("the instrument") is only approved for use in applications described in the Operating Instructions. Any other use is not permitted and can lead to accidents or the destruction of the device. Non-approved use will result in the immediate expiration of all guarantee and warranty claims against the manufacturer.

	<p> <b>WARNING</b></p> <p>Serious malfunctions leading to personal injury or damage to property can result when this product is used in applications that do not comply with the given specifications or if you disregard the operating instructions and warning notes.</p>
--	--

#### 1.2 Qualified personnel



These operating instructions have been written for skilled personnel who are familiar with the valid regulations and standards relevant to the application area.

#### 1.3 Accuracy of the technical documentation

These operating instructions were created with the utmost care and attention. However, we offer no guarantee that the data, graphics and drawings are correct or complete. This document is subject to alteration without notice.

## 1.4 High pressure applications

### Selection

	 <b>DANGER</b>
	<p>When selecting pressure components, ensure that the overload pressure will not be exceeded. It is possible that the pressure cell can be deformed when the overload pressure is exceeded (depending on the duration, frequency and level of the pressure spike).</p> <p>The "diesel effect" caused by entrapped air can result in pressure spikes that far exceed the maximum pressure.</p> <p>The nominal pressure of the pressure component should be higher than the nominal pressure of the system to be measured.</p>

### Installation

	<b>ATTENTION</b>
	<p>Please follow the instructions and observe the correct tightening torques for fittings and adapters.</p>

## 1.5 Service and repair

Please contact our sales office for assistance with repairing or calibrating measuring instruments.

### 1.6 Notes on disposal

#### Recycling in compliance with WEEE

After purchasing our product, you have the opportunity to return the device to the sales branch at the end of its life cycle.



The EU Directive 2002/96 EC (WEEE) regulates the return and recycling of old electrical and electronic devices. As of 13/8/2005 manufacturers of electrical and electronics equipment in the B-2-B (business-to-business) category are obliged to take back and recycle WEEE free of charge sold after this date. After that date, electrical devices may not be disposed of through the "normal" waste disposal channels. Electrical equipment must be disposed of and recycled separately. All devices that fall under this directive must feature this logo.

#### Can we be of assistance?

We offer you the option of returning your old device to us at no extra charge. We will then professionally recycle and dispose of your device in accordance with the applicable laws.

#### What do you have to do?

Once your device has reached the end of its lifespan, simply return it by parcel service (in the box) to your sales branch. We will then take care of the recycling and disposal. You will incur no costs or suffer any inconvenience.

#### Any questions?

Please contact us if you have any additional questions.



## 2. Device version/Scope of delivery/Updates

The basic configuration of your measuring instruments includes the following:

- An integrated hand grip
- A 24 V DC / 2.5 amp power supply unit with regional adapters
- An M8x1 cable adapter for connecting to D-IN / D-OUT
- USB 2.0 cable
- LAN cable
- 1 GB microSD memory card
- A hard-copy quick guide, with complete operating instructions in electronic form (included in delivery)
- PC analysis software (included in delivery)

Multiple connection ports for sensors and signal transmitters are available; the actual number depends on the model of your measuring instrument. (Refer to the ratings plate located on the back of the instrument for the model and version number.)

- Ratings plate model SR-HPM-6016-05-0C-CAN:
    - Ports for two CAN-bus networks for a maximum of
    - 16 CAN-bus sensors ((CANX, CANY)
    - Port for one digital input (D-IN)
    - Port for one digital output (D-OUT)
    - Slot for microSD memory card, USB and LAN ports
  - Ratings plate model SR-HPM-6116-05-0C-CAN:  
In addition to the features of the SR-HPM-6016-05-0C-CAN model, the following ports are available:
    - Ports for three analogue sensors with automatic sensor-ID functionality
    - Ports for two analogue signal transmitters without sensor-ID functionality
  - Ratings plate version SR-HPM-6216-05-0C-CAN:  
In addition to the features of the SR-HPM-6016-05-0C-CAN model, the following ports are available:
    - Ports for six analogue sensors with automatic sensor-ID functionality
    - Ports for four analogue signal transmitters without sensor-ID
- The "Accessories" Chapter includes more information about the available accessories that are not included in delivery.

### 2.1 Updates – Updating the instrument firmware

The user can keep the measuring instrument up to date by updating the instrument's firmware. The update process is described in this section.



From the DEVICE menu, open up the DEVICE INFO sub-menu. The current firmware version will be shown.

Files with a \*.CAB extension are used for the update. These files are copied to the measuring instrument. The USB flash drive should be used to transfer the files.

- 1 Copy the \*.CAB file (without the sub-directory) from the PC to the USB flash drive.
- 2 Disconnect all sensors that may be connected to your measuring instrument.
- 3 Start up the instrument and wait until the message "NO SENSOR" appears.
- 4 Connect the USB drive to the instrument and wait until "USB" is displayed.
- 5 Briefly press the ON/OFF key.
- 6 Wait for the following to appear on the display:

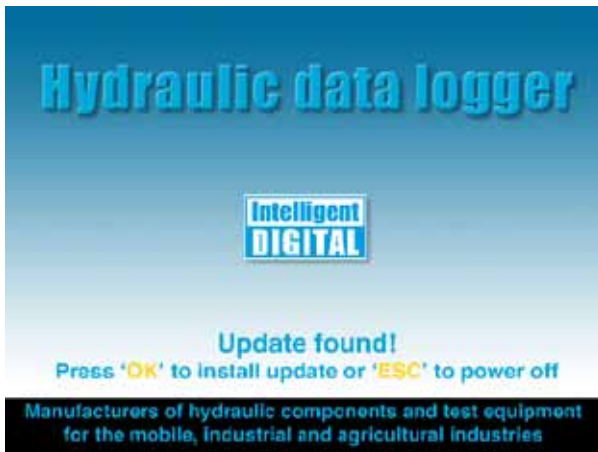

- 7 Press OK to follow the displayed instructions. Wait until the file has been copied to the instrument.
- 8 After the instrument turns off, restart it by pressing the ON/OFF button.
- 9 The firmware on the instrument will be updated.

### 3. Instrument description

This portable multi-function measuring instrument is used in hydraulic applications for measuring pressure, temperature, volumetric flow, and flow. It is capable of measuring, monitoring, analyzing and saving data. Applications are available for machine optimization and service/maintenance tasks.

This instrument can simultaneously record and process measurements from up to 54 channels or up to 26 sensors. The sensors are connected on two electrically isolated CAN-bus networks (M12x1 connector) as well as the standard analogue inputs (Push-Pull plug). The parameterization of units and measuring ranges is automated on sensors with automatic sensor-ID functionality (with up to 1 ms scanning rate). The analogue signal from sensors without sensor-ID functionality can also be used at a scanning rate up to 0.1 ms. A digital input and a digital output are also directly available.

After the instrument is turned on, the measured values from the connected sensors that have automatic sensor-ID are shown. The operator can select various display types, including numeric (4), numeric (8), bar graph, indicator gauge or curve chart. Measurement types are also available for recording measurements (Start/Stop measuring, point measuring and trigger measuring). Each recorded measurement process can consist of up to 4 million individual measured values. The entire measurement memory can contain more than one billion measured values (depending on the size of additional memory used such as microSD cards or USB drives).

A PC or Ethernet network can be connected using the USB and LAN ports. The PC-based analysis software can then use this connection to analyse measurements and control the instrument remotely.

All ports on the instrument are covered with rubber caps to protect them from being touched and from dust and moisture.

## Instrument description



Option	Description
A	Input module (optional)
B	Additional input module (optional)
C	Input and outputs on the base instrument
D	Communication ports
E	Screen
F	Keypad
G	Protective sleeve for housing

- ▶ The "Menu Navigation Basics" Chapter includes more information about the keypad.

### 3.1 Ports on the base instrument

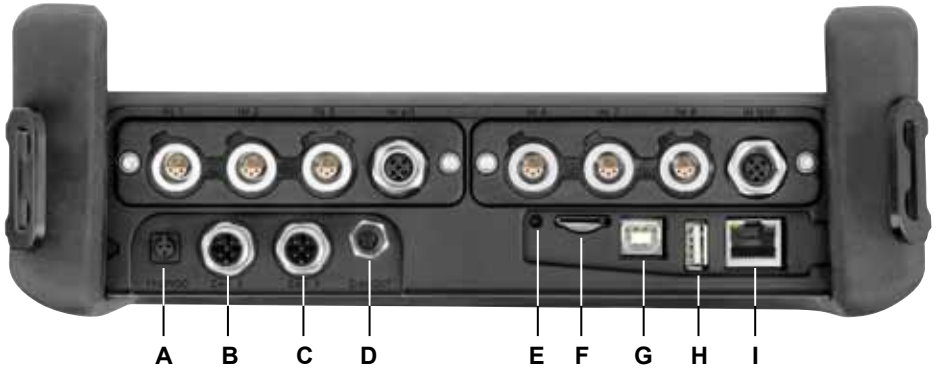

Ports on the base instrument

Option	Description
A	Power supply connection (11-30VDC)
B	CAN-Bus network CAN X
C	CAN-Bus network CAN Y
D	Digital input/output (D-IN-OUT)
E	Reset
F	Slot for Micro SD memory card
G	USB (device) connection to PC
H	USB (host) port for devices such as USB flash memory.
I	Ethernet LAN

## Instrument description

### 3.2 Input module connections

#### 3.2.1 Input module, model 01

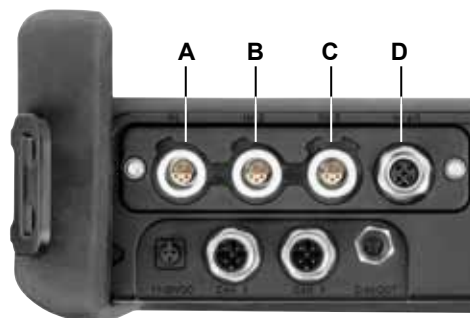

Connections for input module, model 01

Option	Description
A	Analogue input 1 for sensors with automatic sensor-ID (IN1 and IN6)
B	Analogue input 2 for sensors with automatic sensor-ID (IN2 and IN7)
C	Analogue input 3 for sensors with automatic sensor-ID (IN3 and IN8)
D	Analogue input (M12) for sensors without sensor-ID (IN4/5 and IN9/10)

## 4. Connecting inputs and outputs

This chapter contains basic information about connecting a variety of sensors.

- ▶ The "Instrument Description" Chapter contains further details about the port layout on the base instrument model and the optional input modules.
- ▶ Additional information about connecting specialized sensors can be found in the corresponding operating instructions.

### ATTENTION



Be sure that the plastic caps are covering any unused ports. There is no guarantee that the instrument will be properly protected against dust and splashed water when the inputs or outputs are uncovered. IP64 protection is ensured only when all plastic caps are on, or when the CAN network is in use, or when using analogue sensor without sensor-ID.



A sensor that is connected while a measurement is being recorded is not taken into consideration (i.e., a new channel is not displayed and the measurements from this channel are not saved).

The measurement process is continued even if a sensor is removed during the measuring. Data recorded up to that point from the removed sensor is saved.

### 4.1 CAN-bus sensors

CAN-bus sensors are connected to the CAN X or CAN Y ports on the base instrument.

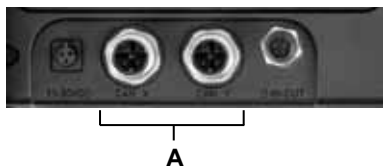

#### A Ports for CAN bus sensors (CAN X, CAN Y)

Up to eight CAN-bus sensors can be connected via the bus line to each CAN-bus sensor port (CAN X, CAN Y). If more than one sensor is connected to a bus line then an additional Y splitter must be used. The measuring instrument automatically detects the measurement units and measurement range of the CAN-bus sensors. After a brief automatic parameterization process, measurements are transmitted and displayed on the instrument screen.

## Connecting inputs and outputs

Connections can be made quickly and securely by inserting and turning (from 90° to 180° rotation) the connector.



CAN-bus sensors should preferably be connected to the instrument in the following order:

- 1 Connect the sensors at the application (the hydraulic connection).
- 2 Connect the sensor cabling.



- A Connection cable
- B Y splitter
- C Terminating resistor
- D CAN sensor

- 3 Connect the bus cable to the switched-on measuring instrument.
  - 4 The instrument searches for the sensors and the measured values for the connected sensors or signal transmitters are then displayed.
- The operating instructions for the corresponding CAN-bus sensor include additional information about connecting the sensor.



### 4.2 Digital IN/OUT

Digital inputs and outputs are connected to the D-IN/OUT port on the base instrument. Connections for digital inputs and outputs should be made as shown in the following illustrations.



A

A D-IN/OUT port

	Pin number	Pin assignment
	Pin 1	DIGITAL-IN +
	Pin 2	DIGITAL-IN GND
	Pin 3	DIGITAL-OUT +
	Pin 4	DIGITAL-OUT GND

Digital IN/OUT pin assignment

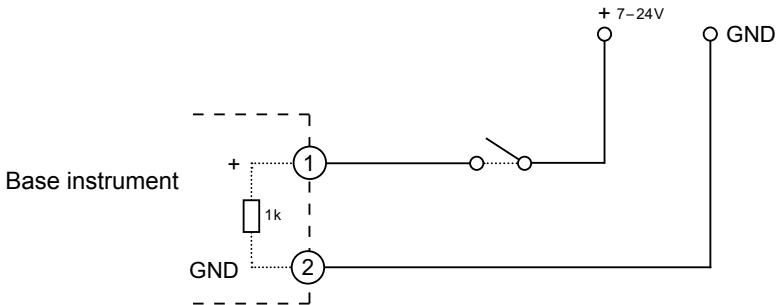

Example connection for D-IN

## Connecting inputs and outputs

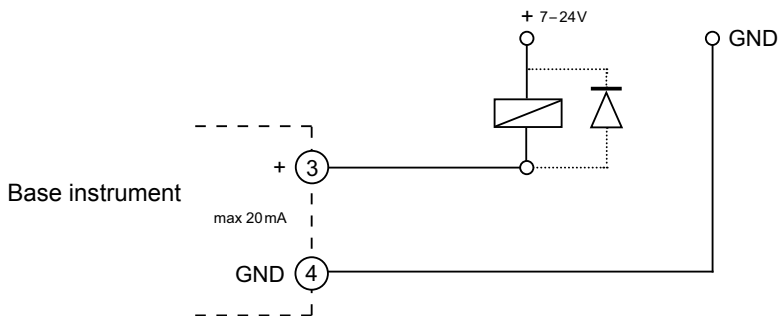

Example connection for D-OUT

### 4.3 Analogue sensors with automatic sensor-ID

Analogue sensors with automatic sensor-ID are connected to the analogue inputs IN1 to IN3 of the first optional input module and IN6 to IN8 of the second optional input module.



**A**

**A** Analogue ports IN1 – IN3



**B**

**B** Analogue ports IN6 – IN8

The instrument automatically detects the unit of measure and the measuring range of the analogue sensor. So it is not necessary to make any setting adjustments on the instrument.

#### 4.4 Sensors without sensor-ID

There are two ways to connect sensors which do not have the sensor-ID feature to the instrument:

- 1 Direct connection: Sensors without sensor-ID are connected to the analogue input IN4/5 of the first optional input module or to analogue input IN9/10 of the second optional input module.

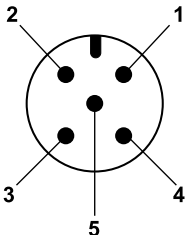
	Pin number	Pin assignment
	Pin 1	+Ub, power supply for sensors IN4/5 and IN9/10
	Pin 2	Measurement signal IN4 / IN9
	Pin 3	GND, for IN4 / IN9
	Pin 4	Measurement signal IN5 / IN10
	Pin 5	GND, for IN5 / IN10

Pin assignments for sensors without sensor-ID

- 2 The second way to connect a sensor without sensor-ID is to use an adapter. The adapter is connected between the sensor without sensor-ID and the analogue sensor port with automatic sensor-ID (IN1-3, IN6-8).
  - Additional information on using an adapter to connect sensors without sensor-ID can be found in the instructions for the current/voltage converter.

After connecting a sensor without sensor-ID, select the INPUT sub-menu from the main menu and specify the settings for the electrical connection and expected signal that correspond to the connected sensor.

- The "Menu Options" Chapter (refer to the "SENSOR menu" section) describes the INPUT sub-menu.

## Power supply

### 5. Power supply

Power is supplied to the measuring instrument using either the integrated rechargeable battery or an external power supply unit. The power supply unit should be connected to the power connection on the main instrument.



A

#### A Power connection



If the battery voltage falls below a minimal level, the current measurement is stopped and any measured values are saved. All user parameters are saved before the measuring instrument shuts down.

#### 5.1 Charging the battery / battery status indicator

Connect the base instrument to the power supply unit in order to recharge the battery.

The maximum charge time is about three hours (also while running with connected sensors). The battery charge status is displayed during the charging process (  ).



The battery can also be recharged when the instrument is turned off.

#### 5.2 Changing the battery

Contact your sales representative for more information if you need to switch batteries.

## 6. Menu Navigation Basics

### 6.1 Keys and functions



The keypad

Key	Description
A	Turns the instrument on and off
B	Main menu (basic settings)
C	Keys for entering numbers, letters and special characters
D	Save the current screen display as a graphic file (The LOAD FILE window then opens and the screen graphic file name can be specified.) ▶ The "Menu Options" Chapter (refer to the "VIEW menu" section) describes the LOAD FILE sub-menu.
E	Navigation keys
F	Function keys

# Menu Navigation Basics

## 6.2 Screen layout

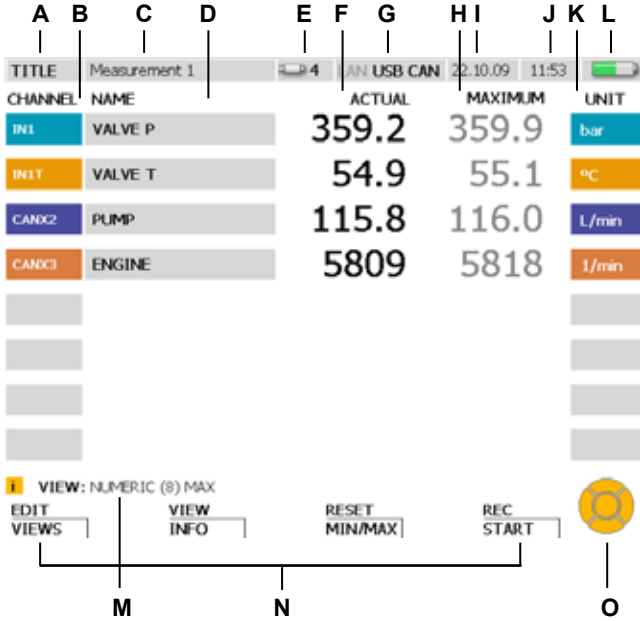



Display





Field	Description
A	TITLE: Indicates that an individual measurement will be carried out. Or: PROJECT: Indicates that a project (including project parameters) is loaded and will be processed.
B	Designates the active/connected channels with color assignments.
C	The name of the measurement or project.
D	The channel name (this is initially the sensor serial number for CAN-bus sensors).
E	The number of active channels.
F	The currently measured value of the channel.
G	Indicates which interface (LAN, USB, CAN) is active. Black active; grey: inactive.
H	Optional display selection: maximum or minimum value that has occurred during the current measurement, or the full scale (final) value (MAXIMUM, MINIMUM, FS).

Field	Description
I	The date display.
J	The time display.
K	The measuring unit with color coding. <ul style="list-style-type: none"> <li>▶ (The "Menu Options" Chapter (refer to the "EDIT menu" section) describes how the display can be customized.)</li> </ul>
L	Battery symbol: The bar indicates the current battery charge. Green: Battery charge is greater than 66%. Yellow: Battery charge is between 33% and 66%. Red: Less than 33% battery charge remaining.
M	Status bar: containing notices, instructions and measurements for the operator.
N	Context-sensitive assignment of function keys F1 through F4.
O	Indicates which navigation keys can be used at the current moment.

## 6.3 Symbols and navigating the menus

This section describes the menu navigation and gives examples on how to use the menu options.

Conventions	Description
	Cursor position: indicates where the entry will be made.
	Dark blue marking: indicates which field will be overwritten.
	Light blue marking: indicates which field has been selected.

Keys	Function
	The arrow keys are used to move the blue cursor to another field, for making a menu selection, or for scrolling to other channels which are not currently being shown. The navigation key icon on the screen shows which arrow is currently being used (as shown in the illustration under section 6.2 "Screen layout").
	The OK key is used for selecting or confirming a selection. All of the operations described here must be confirmed with the OK key.
	The ESC key deletes the entry and closes the menu, window or field.
	These keys are used for entering numbers, letters and special characters. You can press the same key repeatedly to select one of the characters that appears on that key. The sequence in which the characters are displayed is dependent on the currently selected field or opened window. Only the number keys are activated when a numeric entry is expected for a particular entry or window. If a name or comment should be entered in the selected field then the letters appear first and the numbers next. Press the CLR key in order to delete the last character entered.

The function keys open one of the corresponding menus. For example, the EDIT menu open after the F1 key is briefly pressed. The VIEWS menu opens after the F1 key has been pressed and held for two seconds. The VIEWS menu is also found in the EDIT menu.





### 6.3.1 Entering text in a field



Press for two seconds.

Press the F1 key to open the EDIT - VIEWS window.

The NAME field for channel IN1 is selected in the EDIT - VIEWS field.

- 1 Select the required field.

3 x



Press the down arrow key three times in order change the selection in the NAME field from channel IN1 to CANX3. The current name of the selected channel is #123.

- 2 Open



Press OK to open the selected field NAME of channel CANX3.

CHANNEL	NAME
IN1	VALVE P
IN1T	VALVE T
CANX2	PUMP
CANX3	#123

CANX3	#123
-------	------

CANX3	#123
-------	------

# Menu Navigation Basics

## 3 Entering text



Use the entry keys for writing in the field. The new text will overwrite any existing text that is highlighted. For example:

Key	Result
3 (2 x)	E
6 (2 x)	N
4	G
4 (3 x)	I
6 (2 x)	N
3 (2 x)	E

## 4 Confirm



OK confirms the change. The channel CANX3 has been assigned the new name ENGINE.

### 4a Delete

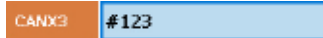

ESC restores the previous entry #123.

## 6.3.2 Selecting menu options

### 1 Highlight



Select the sub-menu using the arrow keys if necessary. The currently selected option is SD.



### 2 Open



OK opens the menu selection.

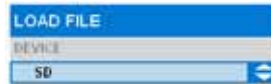

### 3 Select



Select the menu option using the arrow keys.

For example: press the down arrow key to select the entry USB which is below the entry SD.

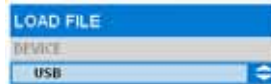

### 4 Confirm



OK confirms the change. The currently selected option is USB.



### 4a Delete



ESC restores the previous entry SD.



# Menu Navigation Basics

## 6.3.3 Selecting from a list

The current unit of measurement (bar) is displayed. This is shown with a green point.



### 1 Highlight

3 x



Select the fourth option on the list using the arrow keys:

Press the bottom arrow three times in order to change the selection from bar to psi.



### 2 Confirm



OK confirms the highlighted selection. A green point is shown before psi.



### 6.3.4 Navigating the sub-menus

Example (selecting the TRIGGER-LOGIC sub-menu from the REC menu using the F4 key):

- 1 Open the menu

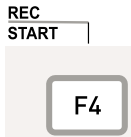

Menus can be opened using the menu button, the function keys (F1 – F4) or from currently opened menus.

F4 opens the REC menu.

- 2 Select

3 x

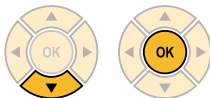

Select the fourth menu option. Press the down arrow three times. The TRIGGER-LOGIC sub-menu is then highlighted.

OK confirms the highlighted selection.

The selected window is then displayed.

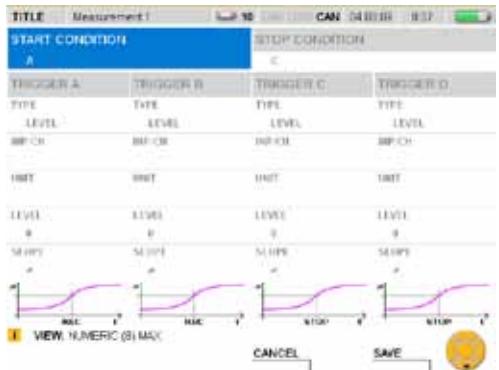

Select the sub-menu and make setting changes as desired.

## Menu Navigation Basics

### 3 Confirm or delete

SAVE

Press the F4 key in order to save your entry.



CANCEL

Press the F3 key in order to delete your entry and return to the main menu.



### 6.4 Quick navigation

Example (selecting the TRIGGER-LOGIC sub-menu from the REC menu using the F4 key):

#### 1 Open the menu

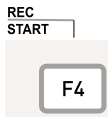

Menus can be opened using the menu button, the function keys (F1 – F4) or from currently opened menus.

F4 opens the REC menu.

#### 2 Select



Entry:  
4

Select the fourth menu option on the list using the entry keys.

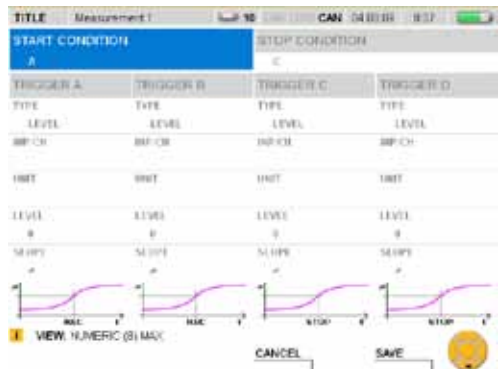





Start the measurement.

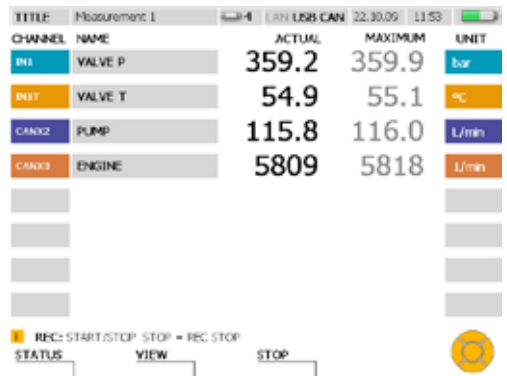

**i** The blinking REC icon in the status bar shows that the measurement process is underway.

## 7.2 Changing the display

Change to another type of display (GAUGE shown here).

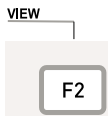

3 x

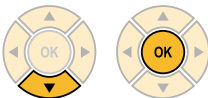

## Quick-start measurements

### 7.3 Monitoring measurements

STATUS



Displays measurement information in the STATUS window.

A green point behind REC indicates that measured values are being saved: START/STOP displayed.



Return to the previous display mode.

BACK



## 7.4 Ending the measurements

Save the results of the measurement.



Select a storage medium for the DEVICE menu option (flash device, SD card, USB flash memory). This is described in the section "Selecting menu options" in the "Menu Navigation Basics" Chapter.

Enter a desired filename in the FILENAME section. The name can be no longer than 16 characters. Select NOTE if you would like to attach a comment to the file. The comment can be no longer than 200 characters.

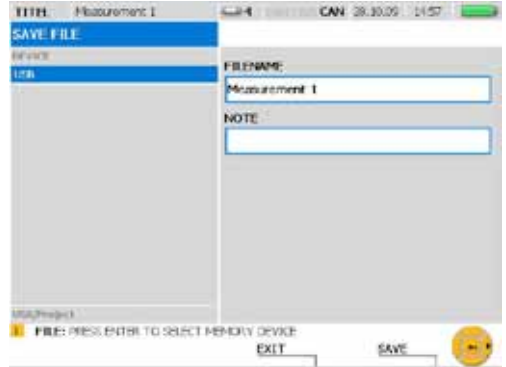

The F4 key allows you to save all measurements displayed in the SAVE FILE window using the specified settings. The SAVE FILE windows closes after the measurements have been saved.

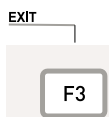

You can use the F3 key to delete the recorded measurements and exit the SAVE FILE window.

# Menu Options

## 8. Menu Options

This chapter describes all contents (field and specific key functions) found in the main menu and in the EDIT, VIEW, RESET and REC menu.

- ▶ More information on the commonly used key functions SAVE and CANCEL can be found in the "Symbols and using the menu" section in the "Menu Navigation Basics" Chapter.

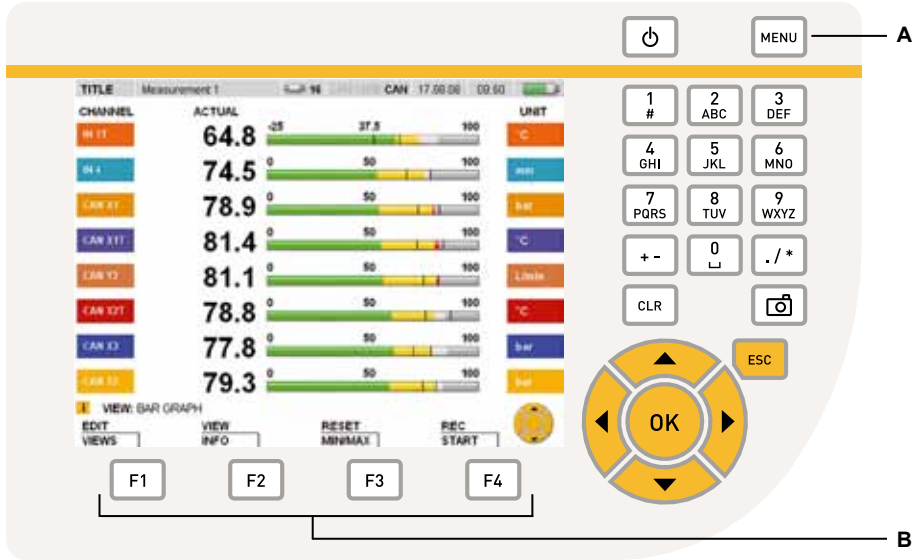

Menu keys

A Main menu

B Function keys

Menu key	Function
	Press the MENU button in order to change the basic settings for the instrument, the connected sensors, data communication and data storage. The main menu is then displayed. ▶ Section 8.1 contains more information about the main menu.
	You can use the EDIT menu to customize the display of measured values and graphs. Additional calculating channels can also be added. ▶ Section 8.2 contains more information about the EDIT menu.
	You can change the arrangement and display of measurement channels and values in the VIEW menu. This menu also allows you to view saved measurements and information on the connected sensors. ▶ Section 8.3 contains more information about the VIEW menu.
	You can reset the minimum and maximum values as well as the D-IN and D-OUT counters in the RESET menu. Null and offset values can be set for each channel in order to zero balance the measurement and calculation channels. ▶ Section 8.4 contains more information about the RESET menu.
	The REC menu allows you to select and adjust the type of measurement and also to initiate the measurement process. ▶ Section 8.5 contains more information about the REC menu.

MENU

Press the MENU button in order to change the basic settings for the instrument, the connected sensors, data communication and data storage. The main menu is then displayed.

▶ Section 8.1 contains more information about the main menu.

EDIT  
VIEWS

F1

You can use the EDIT menu to customize the display of measured values and graphs. Additional calculating channels can also be added.

▶ Section 8.2 contains more information about the EDIT menu.

VIEW  
INFO

F2

You can change the arrangement and display of measurement channels and values in the VIEW menu. This menu also allows you to view saved measurements and information on the connected sensors.

▶ Section 8.3 contains more information about the VIEW menu.

RESET  
MIN/MAX

F3

You can reset the minimum and maximum values as well as the D-IN and D-OUT counters in the RESET menu. Null and offset values can be set for each channel in order to zero balance the measurement and calculation channels.

▶ Section 8.4 contains more information about the RESET menu.

REC  
START

F4

The REC menu allows you to select and adjust the type of measurement and also to initiate the measurement process.

▶ Section 8.5 contains more information about the REC menu.

# Menu Options

## 8.1 Main menu

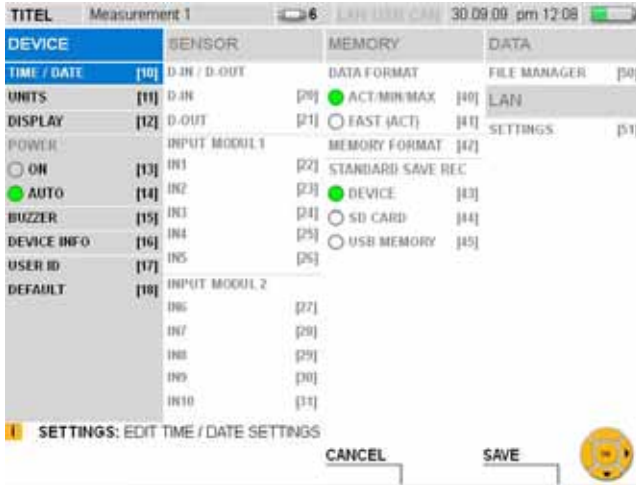

### MENU window

Field	Function
DEVICE	The DEVICE menu allows you to adjust the instrument's settings (such as display intensity, signal tone, time and date). You can also specify the measurement units and your user ID in this menu.
SENSOR	The SENSOR menu allows you to change the settings on the sensors connected that do not have automatic sensor-ID. You can change the settings on connected current and signal transmitters here. This menu also allows you to configure the digital ports.
MEMORY	The MEMORY menu allows you to change the settings for the data format, the recording rate and the target memory media.
DATA	The DATA menu allows you to open, copy and delete directories and files.
LAN	The LAN menu allows you to change the LAN connection settings.

### 8.1.1 DEVICE menu

The DEVICE menu allows you to adjust the instrument's settings (such as display intensity, signal tone, time and date). You can also specify the measurement units and your user ID in this menu.



DEVICE menu option

Field	Function
TIME / DATE	Select the TIME / DATE sub-menu in order to change the date, time and display format.
UNITS	Select the UNITS sub-menu in order to select the measurement units.
DISPLAY	Change to the DISPLAY sub-menu in order to adjust the background illumination.
POWER	Select AUTO if you would like to activate the automatic shut-off feature. Select ON if you would like to deactivate the automatic shut-off feature.
BUZZER	Select the BUZZER sub-menu in order to turn off or on the signal buzzer associated with the instrument's various actions.
DEVICE INFO	Select the DEVICE INFO sub-menu in order to display information about the measuring instrument.
USER ID	Select the USER ID sub-menu in order to change user information.
DEFAULT	This resets the values in the DEVICE menu to the factory default settings.



The automatic shut-off feature turns the instrument off if no key has been pressed for twenty minutes. This function is never active while a measurement or recording process is underway. It is also not active when the power cord is plugged in.



English is preset as the default language for the instrument. Use the PC analysis software to change the language. Contact your sales representative if your language is not on the list of available languages.

# Menu Options

## DEVICE menu - TIME / DATE sub-menu

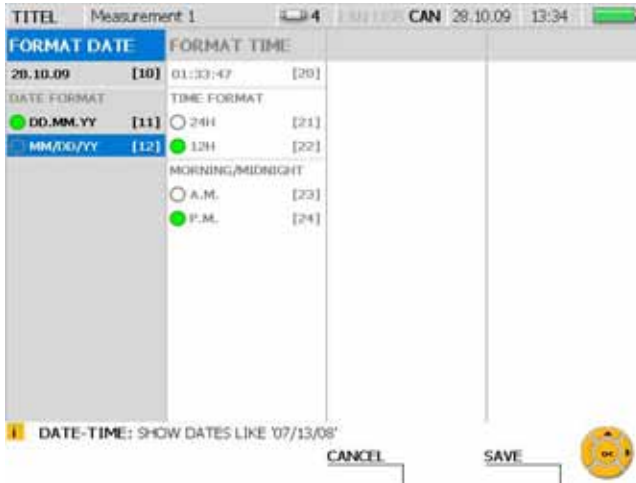

### TIME / DATE window

Field	Function
FORMAT DATE	Enter the date here.
DATE FORMAT	Select a date format.
FORMAT TIME	Enter the time here.
TIME FORMAT	Select a time format (12 or 24 hour).
MORNING/ MIDNIGHT	If you have selected the 12-hour time format, select a time format (morning or afternoon) here.



Changes in the settings effect measurements and the creation of projects.



## DEVICE menu - UNITS sub-menu



## UNITS window

Field	Function
PRESSURE	Select a measurement unit for pressure.
TEMPERATURE	Select a measurement unit for temperature.
FLOW	Select a measurement unit for flow.
SPEED	Select a measurement unit for speed.
POWER	Select a measurement unit for power.



The selected units are then applied. The measured values are recalculated to match the new units.



For channels from analogue sensors without automatic sensor-ID, units can be selected in the sub-menus for input modules 1 and 2. They can also be specified directly by the user.

- ▶ The "Menu Options" Chapter (refer to the "SENSOR menu" section) gives more information.

## Menu Options

### DEVICE menu - DISPLAY sub-menu

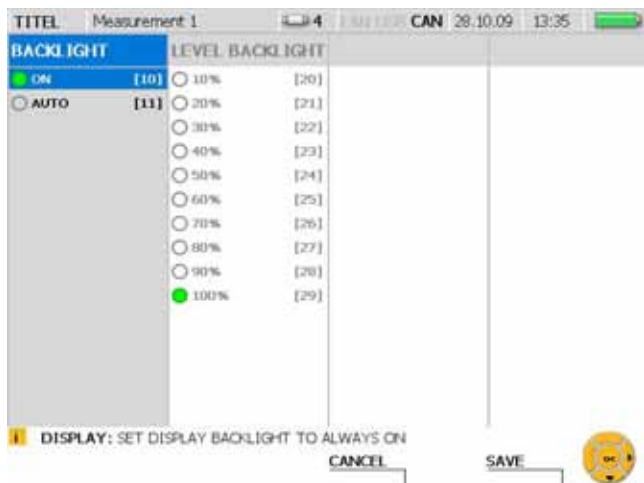

### DISPLAY window

Field	Function
BACKLIGHT	Select ON in order to turn on the background light permanently. Select AUTO to activate the energy saving mode.
LEVEL BACKLIGHT	Select a brightness intensity value for the background illumination.

## DEVICE menu - BUZZER sub-menu

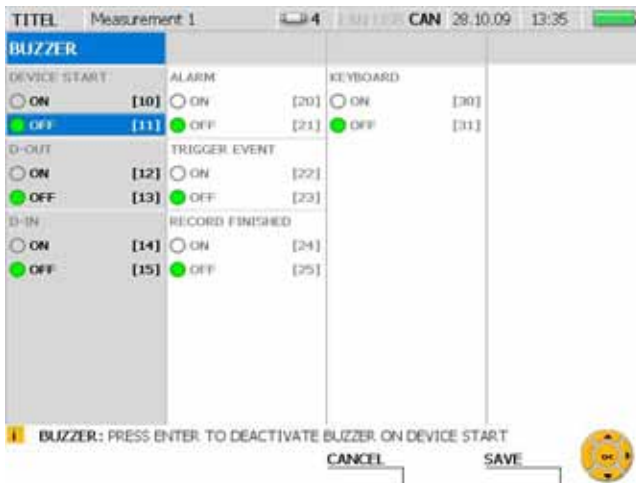

## BUZZER window

Field	Function
DEVICE START	Turn the signal buzzer off or on as the instrument start signal.
D-OUT	Turn the signal buzzer for the D-OUT signal off or on.
D-IN	Turn the signal buzzer for the D-IN signal off or on.
ALARM	Turn the signal buzzer for exceeding an alarm level off or on.
TRIGGER EVENT	Turn the signal buzzer for a trigger event off or on.
RECORD FINISHED	Turn the signal buzzer for the end of measurement process off or on.
KEYBOARD	Turn the signal tone for a key press off or on.

# Menu Options

## DEVICE menu - DEVICE INFO sub-menu

The screenshot shows the 'DEVICE INFO' sub-menu. At the top, there is a header bar with 'TITLE Measurement 1', a signal strength indicator, '10', 'CAN', '08.07.09', '10:57', and a battery icon. Below this, there are three input fields: 'ADDRESS', 'COMPANY', and 'DEPARTMENT', each followed by a text entry area. Underneath, there is a table for 'MEMORY' with columns 'USAGE [kB]' and 'TOTAL [kB]'. The rows are 'FLASH' (1002 / 128000) and 'SD CARD' (124 / 64000). Below that is another table for 'TYPE' with columns 'S / N' and 'FIRMWARE'. The rows are 'IM01-1' (003224 / V1.1), 'IM01-1' (000215 / V1.0), and 'IM01-2' (000354 / V1.3). At the bottom left, there is a yellow icon and the text 'VIEW: DEVICE INFO'. At the bottom right, there is an 'EXIT' button with a yellow circular icon containing the number '5'.

### DEVICE INFO window

Field	Function
ADDRESS	Specifies the instrument manufacturer.
MEMORY	Specifies allocated memory space and maximum capacity of the connected storage media.
TYPE	Specifies the serial number and firmware version of the measuring instrument and attached input modules.
EXIT	Press F4 to exit the window.

## DEVICE menu - USER ID sub-menu

TITEL Measurement 1 4 CAN 28.10.09 13:37

COMPANY MAX MUSTER AG

DEPARTMENT

NAME

STREET

POSTAL CODE

CITY

PHONE

FAX

URL

USER-ID: PRESS OK TO EDIT TEXT

CANCEL SAVE

## USER ID window

Field	Function
COMPANY	Specify the name of your company here.
DEPARTMENT	Specify the department or division within your company.
NAME	Specify your name.
STREET	Specify your street and street number here.
POSTAL CODE	Specify your postal code here.
CITY	Specify your town or city name here.
PHONE	Specify your telephone number here.
FAX	Specify your fax number here.
URL	Specify your web address here.



In the event that you lose the instrument, the information in the USER ID fields can be used to identify you as the owner.

## Menu Options

### 8.1.2 SENSOR menu

The SENSOR menu allows you to change the settings on the sensors connected that do not have automatic sensor-ID. This menu also allows you to configure the digital ports.



The screenshot shows a menu titled "SENSOR" with a blue header. Below the header, there are three main sections: "D-IN / D-OUT", "INPUT MODUL 1", and "INPUT MODUL 2". Each section contains a list of options with corresponding numbers in brackets. The "D-IN / D-OUT" section has "D-IN [20]" and "D-OUT [21]". The "INPUT MODUL 1" section has "IN1 [22]", "IN2 [23]", "IN3 [24]", "IN4 [25]", and "IN5 [26]". The "INPUT MODUL 2" section has "IN6 [27]", "IN7 [28]", "IN8 [29]", "IN9 [30]", and "IN10 [31]".

SENSOR menu option

Field	Function
D-IN / D-OUT	Select D-IN in order to change the digital input settings. Select D-OUT in order to change the digital output settings.
INPUT MODUL 1	Select a channel in INPUT MODUL 1 in order to change the settings for the analogue sensors on input module 1. The VADC MODULE sub-menu (for channels IN1 to IN3) or the INPUT sub-menu (for channels IN4 and IN5) then appears.
INPUT MODUL 2	Select a channel in INPUT MODUL 2 in order to change the settings for the analogue sensors on input module 2. The VADC MODULE sub-menu (for channels IN6 to IN8) or the INPUT sub-menu (for channels IN9 and IN10) then appears.

## SENSOR menu - INPUT sub-menu

The INPUT sub-menu allows you to change the settings on sensors without automatic sensor-ID and on signal transmitters that are connected directly to the measuring instrument.



INPUT window (example: channel IN4)

Field	Function
INPUT	Switch to ON to activate channels 4, 5, 9 or 10 (displays the channel in the value display). Deactivate by switching to OFF.
NAME	Specify a name for the sensor channel. The name can be no longer than 16 characters.
DEFINE TYPE UNIT	Select LIBRARY here if you wish to select a measuring unit from the standard library. Select MANUAL is you want to specify another unit name.
UNIT	Select a measuring unit (in LIBRARY mode) or specify a unit name (in MANUAL mode). The unit name can be no longer than five characters.
FROM TO	Specify the starting point of the measuring range (FROM) and the end value of the range (TO) for the connected sensor.
SIGNAL	Select the signal type for the connected sensor (V or mA) in the SIGNAL field.
FROM TO	In the FROM field, specify the voltage or current value for the start of the measurement range for the connected sensor. Specify the final voltage or current value for the range in the TO field.

## Menu Options

### SENSOR menu - VADC MODULE sub-menu

You can change the settings for sensors without automatic sensor-ID and for signal transmitters in the VADC MODULE sub-menu. Sensors and signal transmitters should be connected to the measuring instrument via a current/voltage converter.



VADC MODULE window

Field	Function
INPUT: IN1	Displays the selected channel (IN1 to IN3 and IN6 to IN8).
NAME	Specify a name for the channel. The name can be no longer than 16 characters.
DEFINE TYPE UNIT	Select LIBRARY here if you wish to select a measuring unit from the standard library. Select MANUAL is you want to specify another unit name.
UNIT	Select a measuring unit (in LIBRARY mode) or specify a unit name (in MANUAL mode). The unit name can be no longer than five characters.
FROM TO	Specify the starting point of the measuring range (FROM) and the end value of the range (TO) for the connected signal transmitter.
SIGNAL	Select the signal type for the signal transmitter (V or mA) in the SIGNAL field.
FROM TO	In the FROM field, specify the voltage or current value for the start of the measurement range for the connected signal transmitter. Specify the final voltage or current value for the range in the TO field.



## SENSOR menu - D-IN sub-menu

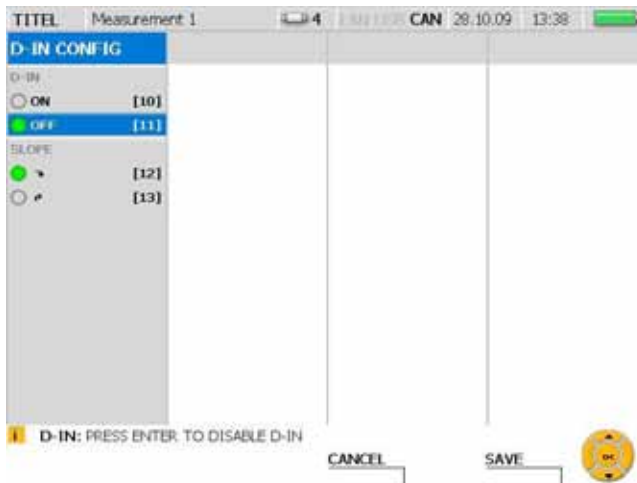

D-IN CONFIG window

Field	Function
D-IN	Switch to ON to activate then channel (displays the channel in the value display). Deactivate by switching to OFF.
SLOPE	Select the type of slope that the display and counter should react to. (↘ = falling slope, ↗ = rising slope).

## Menu Options

### SENSOR menu - D-OUT sub-menu

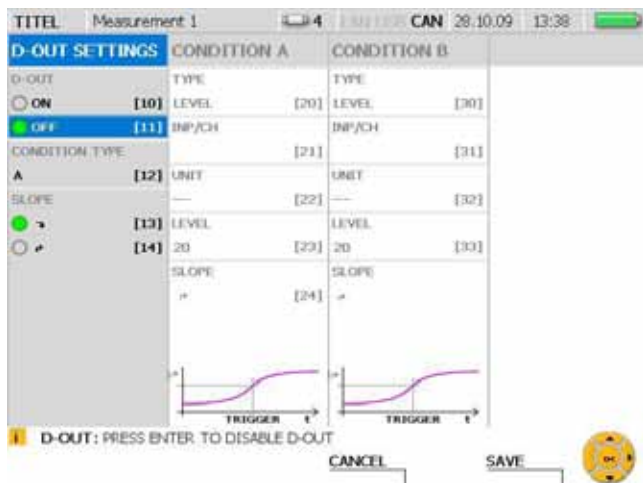

#### D-OUT SETTINGS window

Field	Function
D-OUT	Switch to ON to activate then channel (displays the channel in the value display). Deactivate by switching to OFF.
CONDITION TYPE	Specify whether you would like to have one or two valid trigger conditions. If two trigger conditions are selected, you also need to select the logical operator (AND or OR).
SLOPE/ SWITCH FUNCTION	Select the output function: either NC (normally closed) or NO (normally open). If NC is selected, the switch in the instrument is closed and is then opened when the condition is met. The switch remains open as long as the condition if met. If NO is selected, the switch is initially opened.
CONDITION A	Select the type of trigger and the corresponding parameter for the trigger condition A.
CONDITION B	Select the type of trigger and the corresponding parameter for the trigger condition B.

Trigger type	Parameter field
LEVEL	Channel selection, unit, trigger level, slope
WINDOW	Channel selection, unit, upper and lower limit for the window
CLOCK	Trigger date, trigger time, a.m/p.m
EXTERN	Channel selection, slope

- ▶ Further information about the trigger types can be found in the "Measurement types and memory options" section in the "Notes on Trigger and Trigger Logic Measurements" Chapter.

## Menu Options

### 8.1.3 MEMORY menu

The MEMORY menu allows you to change the settings for the data format and the target memory media.



MEMORY FORMAT memory option

Field	Function
DATA FORMAT	For the standard trigger measurement, select ACT/MIN/MAX (first channel = 1 ms, second T-channel = 1 s). For the quick-trigger measurement, select FAST (ACT) (0.1 ms on channels IN4 and IN9).
MEMORY FORMAT	The measurement parameters, point count and recording rate can be specified in the MEMORY FORMAT menu.
STANDARD SAVE REC	Go to STANDARD SAVE REC in order to select the storage medium that should be the default destination when saving files.

The following table contains information about the various data and memory formats for the different types of measurements:

Type of measurement	DATA FORMAT	MEMORY FORMAT
Start/Stop	always ACT/MIN/MAX	dynamically increasing
Point	always ACT (current value)	individual measured values
Trigger	ACT/MIN/MAX	Points (2000, 4000, 8000, 16000) or recording rate (ms, s, min)
Trigger logic	always ACT/MIN/MAX	dynamically increasing
Trigger (FAST)	always ACT	0.1 ms

- Further information about storage variants can be found in the "Memory options" section in the "Measurement Types and Memory Options" Chapter.

### 8.1.4 DATA menu

The DATA menu allows you to open, copy and delete directories and files to and from the storage media. This menu also displays information on how much memory is available on the SD card, flash device and USB flash drive.



DATA menu selection

Field	Function
FILE MANAGER	Select the FILE MANAGER sub-menu in order to manage or change the directories and files.

#### DATA menu - FILE MANAGER sub-menu

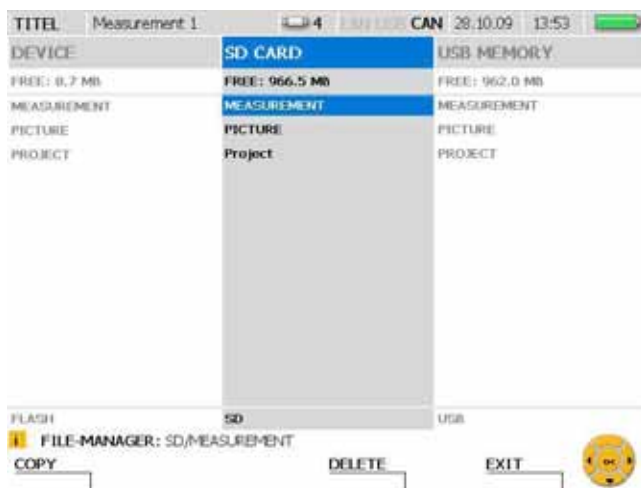

FILE MANAGER window

## Menu Options

<b>Field</b>	<b>Function</b>
DEVICE	Opens the measurement files, other files, images or projects that are stored on the flash device.
SD CARD	Opens the measurement files, images or projects that are stored on the SD card.
USB MEMORY	Opens the measurement files, images or projects that are stored on the USB flash drive.
COPY	Use the F1 key to select the file that you would like to copy.
PASTE	The Paste key appears after the Copy key is pressed. Press the F2 key in order to copy the selected file into another directory.
DELETE	Press the F3 key in order to delete the selected file.
EXIT	Press the F3 key in order to return to the main menu.

### 8.1.5 LAN menu

The LAN menu allows you to change the LAN connection settings.



LAN selection option

Field	Function
SETTINGS	Select the SETTINGS sub-menu in order to change the LAN connection settings.

#### LAN menu - SETTINGS sub-menu



LAN SETTINGS window

Field	Function
CONFIGURATION	Change the network configuration.
ADDRESSES	Change the network addresses.
NAMES	Change the host and domain names.
CERDISP	Activate or deactivate the remote display control functionality. Specify the PC's network IP address for use by the CerDisp remote display control program.

- Additional information about the network connection can be found in the "Basic settings and network connection" section in the "Operations" Chapter.

# Menu Options

## 8.2 F1 - EDIT menu

You can use the EDIT menu to customize the display of measured values and graphs. Additional calculating channels can also be added. Many pre-set formulas are available for this purpose.



EDIT menu

Field	Description
VIEWS	This sub-menu allows you to change some of the basic display settings for the measurement channels.
VIEW CURVE GRAPH	This sub-menu allows you to set and change the time display of the measurements (X axis) in the form of a curve chart.
SET CALC	You can create up to four calculating channels in this sub-menu. You can also carry out a variety of measurement calculations. A selection of standard formulas is available for the calculations.

### 8.2.1 EDIT menu - VIEWS sub-menu

The EDIT - VIEWS sub-menu allows you to define the display format of the various measured values that are available in the VIEW menu.



EDIT - VIEWS window



Field	Description
TITLE	Specify a name for the measurement (no more than 16 characters).
CHANNEL	Input / Output
IN 1	Sensor on input 1 (IN 1), faster channel
IN 1T	Sensor on input 1 (IN 1T), temperature channel
CAN X1	First detected CAN sensor on CAN network X
CAN X1T	First detected CAN sensor on CAN network X, temperature channel
CAN Y1	First detected CAN sensor on CAN network Y
CAN Y1T	First detected CAN sensor on CAN network Y, temperature channel
D-IN	Digital trigger input
D-OUT	Digital trigger output
CALC1	First created calculating channel
NAME	Specify a name for the channel (no more than 16 characters).
RANGE	Displays the measuring range for this channel.
ATT	Specify the measurement value which will be the starting value for the yellow warning range in the BAR GRAPH and GAUGE views.
ALARM	Specify the measurement value which will be the starting value for the red alarm range in the BAR GRAPH and GAUGE views.
POS	Enter one digit (from 1 to the number of active channels) to specify the desired position of the channel in the list. The positional display for the measurement channel will be changed after you save or press the F2 key (SORT POS).
COL	Select the channel color (color of CHANNEL and UNIT fields). A new window then opens up with the color palette. The CURVE GRAPH view displays the measurements in a curve with the specified color.
UNIT	Measurement unit.
SORT POS	Press the F2 key in order to refresh the sorted order of the channels. Any changes made with POS are then updated.

## Menu Options

### 8.2.2 EDIT menu - VIEW CURVE GRAPH sub-menu

You can change the time settings (on the X axis) for the display of the measurement curve.

- ▶ The "VIEW menu - CURVE GRAPH" section describes the curve display options and corresponding tools.

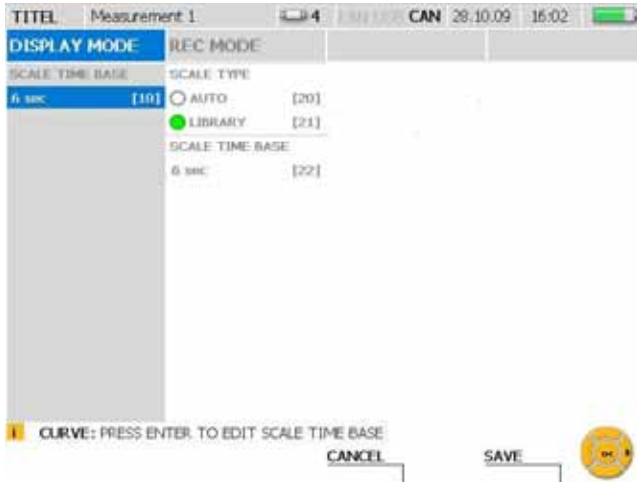

EDIT window - VIEW CURVE GRAPH

Field	Description
SCALE TIME BASE	Specify the time interval that will be displayed for the CURVE GRAPH (6 seconds, 60 seconds or 6 minutes).
SCALE TYPE	Select a scale type. AUTO = automatic scaling used to display all recorded measurements independent of the measurement duration. LIBRARY = displays the measured values within a defined time window as specified under SCALE TIME BASE.

The following table describes the three operational modes of the measuring instrument:

Operational mode	Description
DISPLAY MODE	Displays the measurements without saving.
REC MODE	Displays and records the measurements.

### 8.2.3 EDIT menu - SET CALC sub-menu

Up to four calculating channels can be defined in the SET CALC sub-menu. These channels can be used to perform calculations on measurements from other channels. Mathematical formulas can be selected from the software's database. The database formulas can calculate the sum, difference, volume and power.



EDIT - SET CALC window

Field	Description
CHANNEL	Calculating channel designation and number.
NAME	Specify a name for the calculating channel.
CONFIG STATUS	Select ON or OFF. ON = The calculating channel will be displayed on the screen. The calculated values will be saved during a recorded measurement. The calculated values will be transmitted during an online measurement. OFF = The calculating channel will be deactivated.
CONFIG TYPE	Select a formula (for example, to calculate the volume).
CONFIG CHANNELS	Select the channel that will provide the value (in this example, Q) on which the calculation is based.
FORMULA	The selected formula in mathematical notation (for example, Q*time).



Calculating channels may not be linked to each other.

## Menu Options

The following table describes the available formulas for the calculating channels.

<b>TYPE</b>	<b>Formula</b>	<b>Unit</b>
DIFFERENZ	$INx-INy$	INx
ADDITION	$INx+INy$	INx
VOLUME	$Q*time$	L
POWER1	$P*Q/600$	kW
POWER2	$(p1-p2)*Q/600$	kW

### 8.3 F2 - VIEW menu

You can change the arrangement and display of measurement channels and values in the VIEW menu. This menu also allows you to view saved measurements and information on the connected sensors.



#### VIEW menu

Field	Description
NUMERIC (8)	This numeric view displays eight channels simultaneously on the screen. The display of measurements in this view can be defined from the NUMERIC (8) sub-menu.
NUMERIC (4)	This numeric view displays four channels simultaneously on the screen.
BAR GRAPH	This view displays eight channels simultaneously as bar graphs on the screen.
GAUGE	This view displays two channels simultaneously as indicator gauges on the screen.
CURVE GRAPH	This sub-menu allows you to display the measurements from one of multiple channels as curve graphs. Up to eight channels can be displayed.
FILE	This sub-menu allows you to load saved measurement sets and display them as curve graphs.
SENSOR INFO	This sub-menu displays information about the activated channels.



The actual displayed sequence of the channels can be specified in the EDIT - VIEWS menu.

## Menu Options

### 8.3.1 VIEW menu - NUMERIC (8) sub-menu

The current (numeric) measured values from up to eight channels are simultaneously displayed in the NUMERIC (8) view. This menu also allows you to select which values are displayed next to the ACTUAL column for this channel (maximum value, minimum value and full scale are available).



VIEW menu - NUMERIC (8) sub-menu

Field	Description
VIEW ACT-MAX	Displays the current measured value and the largest measured value.
VIEW ACT-MIN	Displays the current measured value and the smallest measured value.
VIEW ACT-FS	Displays the current measured value and the full scale for this channel.

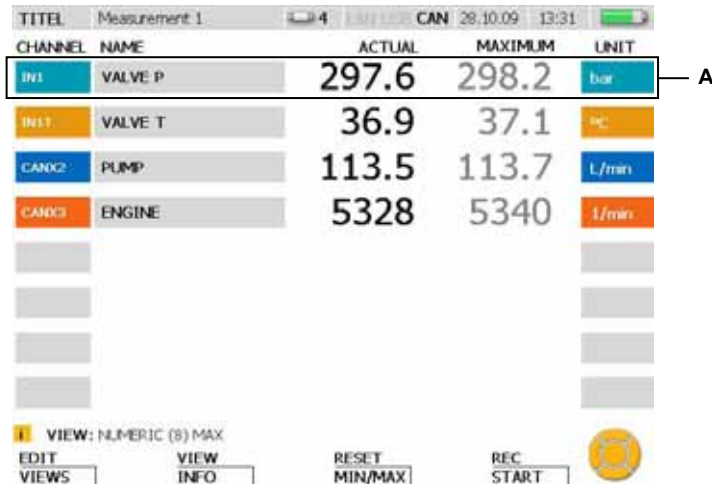

VIEW - NUMERIC (8) window

A Display window for a channel

Field	Description
CHANNEL	Designation of the active channel (input / output).
NAME	Name of the channel.
ACTUAL	Current measured value.
MAXIMUM	The highest value for the current measurement.
or	
MINIMUM	The lowest value for the current measurement.
or	
FS	The full scale (final value) for the channel.
UNIT	Measurement unit.



If more than eight channels are active, they can all be seen by scrolling with the arrow keys.



You can reset the minimum and maximum displayed values from the RESET menu.

## Menu Options

### 8.3.2 VIEW menu - NUMERIC (4) sub-menu

The current (numeric) measured values from up to four channels are simultaneously displayed in the NUMERIC (4) view. The minimum and maximum values for the current measurement for each channel are also displayed.



VIEW - NUMERIC (4) window

A Display window for a channel.

Field	Description
IN1	Designation of the active channel (input / output).
VALVE P	Name of the channel.
357.6	Current measured value.
MIN	The lowest value for the current measurement.
MAX	The highest value for the current measurement.
bar	Measurement unit.



If more than four channels are active, they can all be seen by scrolling with the arrow keys.



You can reset the minimum and maximum displayed values from the RESET menu.



### 8.3.3 VIEW menu - BAR GRAPH sub-menu

The current (numeric) measured values from up to eight channels are simultaneously displayed in the BAR GRAPH view. Measured value data for each channel are also displayed dynamically using a bar graph. The bar graph shows the measurement range, the current measured value, the minimum value, the maximum value, and a three-color division of the range (green: allowed range; yellow: warning range; red: alarm (critical) range).

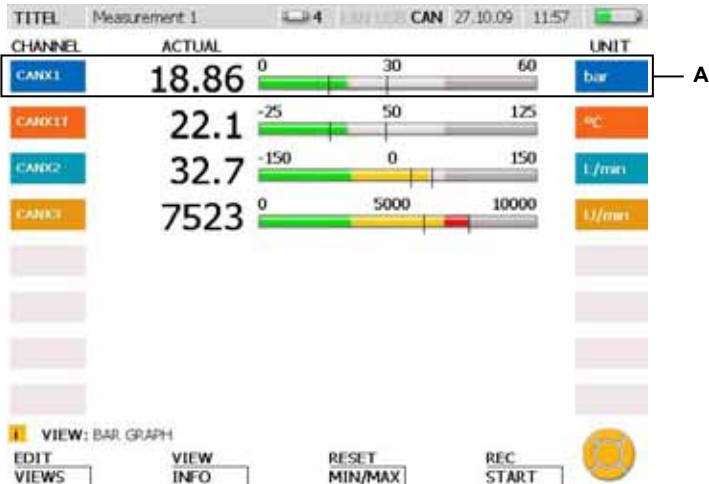

VIEW - BAR GRAPH window

A Display window for a channel

Field	Description
CHANNEL	Designation of the active channel (input / output).
ACTUAL	Current measured value.
	Dynamic bar graph.
UNIT	Measurement unit.

## Menu Options

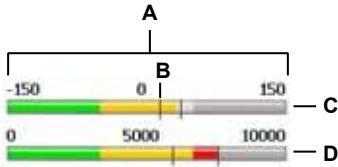

VIEW - BAR GRAPH window, detailed view of bar graph

Field	Description
A	Measurement range for this channel (for example, -150 to 150).
B	Trailing indicator. The left trailing indicator shows the minimum value of the current measurement. The right trailing indicator shows the maximum value. The position of the trailing indicator is updated in real time.
C	Displays the normal range (grey), the warning range (light grey) and the alarm (critical) range (dark grey). This provides a preview for the three ranges which are shown in their actual colors if the value falls within the range.
D	Displays the normal range (green), warning range (yellow) and alarm range (red) for the measured values from this channel. The bar will be displayed in yellow or red as soon as the value reaches the warning or alarm level.



The warning and alarm ranges for each channel can be adjusted in the EDIT menu.

► The "EDIT menu - VIEWS sub-menu" section describes this in more detail.



You can reset the trailing indicator for the minimum and maximum values from the RESET menu.



If more than eight channels are active, they can all be seen by scrolling with the arrow keys.

### 8.3.4 VIEW menu - GAUGE sub-menu

The GAUGE sub-menu displays the current values for two channels using the indicator gauge view. Additional information pertaining to each channel is also shown. The indicator gauge display shows the measurement range, the current measured value, the minimum value, the maximum value, and a three-color division of the range (green: allowed range; yellow: warning range; red: alarm (critical) range).

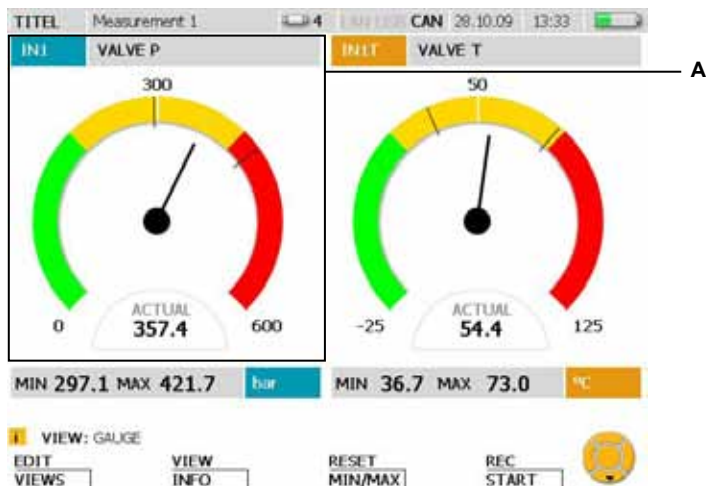

VIEW - GAUGE window

**A** Display window for a channel

Field	Description
IN1	Designation of the active channel (input / output).
VALVE P	Name of the channel.
ACTUAL	Current measured value, displayed numerically
MIN	The lowest value for the current measurement.
MAX	The highest value for the current measurement.
bar	Measurement unit.



If more than two channels are active, they can all be seen by scrolling with the arrow keys.

## Menu Options

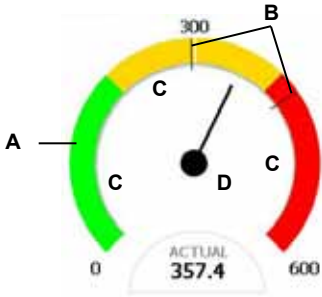

VIEW - BAR GRAPH window, detailed view of indicator gauge

Field	Description
A	Measurement range for this channel (for example, 0 to 600).
B	Trailing indicator. The left trailing indicator shows the minimum value of the current measurement. The right trailing indicator shows the maximum value. The position of the trailing indicator is updated in real time.
C	Displays the normal range, warning range and alarm range for the measured values from this channel. Green: normal range of values for this channel. Yellow warning range of values for this channel. Red alarm (critical) range of values for this channel.
D	Current measured value, displayed with indicator gauge.



The warning and alarm ranges for each channel can be adjusted in the EDIT menu.

▶ The "EDIT menu - VIEWS sub-menu" section describes this in more detail.





You can reset the trailing indicator for the minimum and maximum values from the RESET menu.

## Display of D-IN and D-OUT

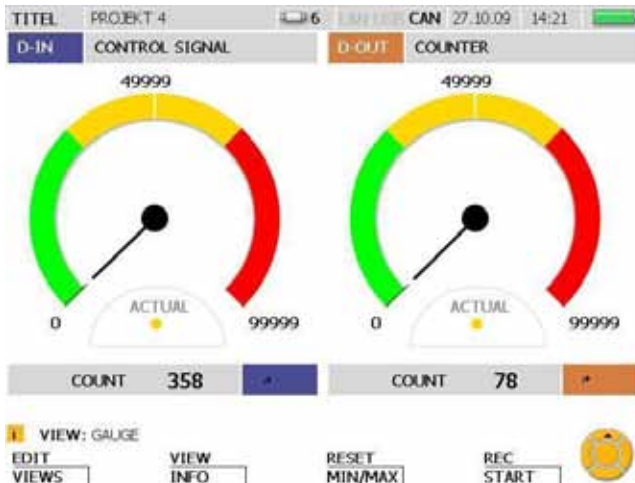
The digital input/output is displayed differently than the other measurement channels. The events are counted and the rising or falling slopes are then displayed for the digital input (D-IN) and the digital output (D-OUT).



VIEW - GAUGE window for D-IN and D-OUT

Field	Description
D-IN	Digital input.
D-OUT	Digital output.
ACTUAL	Digital input (D-IN / D-OUT): The yellow point indicates that the specified condition for a slope (in this case, a rising slope) has not yet been met. Thus the low level is still active. A green point indicates that the specified condition has been met. Thus, in this example, high level has been activated.
COUNT	A counter (COUNT) for the recognized slope changes (D-IN) or events (D-OUT). The counter can increment up to 99999.
	Symbol for falling slope.
	Symbol for rising slope.



D-IN and D-OUT settings can be adjusted from the main menu.

► Further details can be found in the "Main menu" Chapter.

## Menu Options

### 8.3.5 VIEW menu - CURVE GRAPH sub-menu

The CURVE GRAPH sub-menu displays the measured values from the selected sensors as a curve graph along with additional information. You can use the arrow keys to select particular curves or to remove them from the display. The CURVE function allows you to display an X-Y graph of two channels. It also allows you to display or hide grid lines. The TOOLS function can be used to enlarge a particular section or to analyze curves.

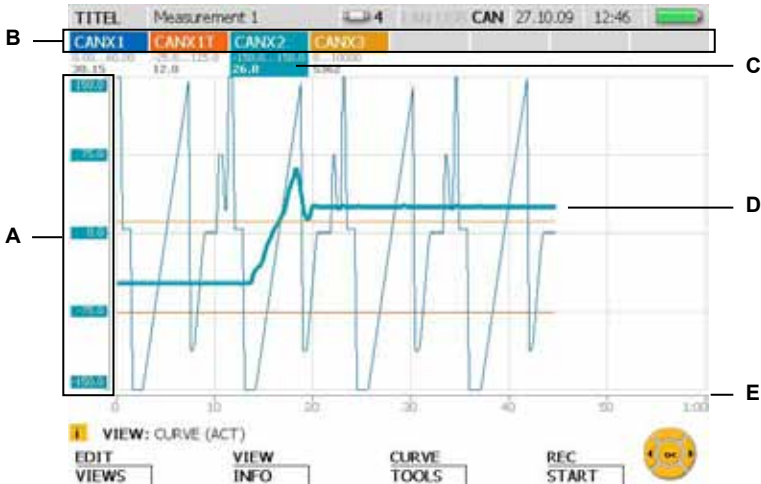

VIEW - CURVE GRAPH window

Field	Description
A	Y-axis: Axis label, valid only for the selected channel (measuring range, color).
B	Designation of the channels (positions 1 through 8) ( input / output).
C	Measuring range for the selected channel (for example, -150 to 150) and the current measured value.
D	Plotted curve for the measurements. The selected channel is highlighted using a thicker dashed line.
E	X-axis: Time.
CURVE	Press the F3 key in order to change to the CURVE sub-menu.
TOOLS	Press and hold the F3 key for two seconds in order to go directly to the TOOLS sub-menu.

**i** While measured values are being recorded and displayed, another channel can be selected by using the arrow keys (left and right) or by entering the channel's position number using the keyboard.

**i** Individual channels can be selected for display or removed from display as follows. Press and hold (for three seconds) the position number of the channel to toggle whether a channel is displayed or not. Toggle the display of the currently selected channel by pressing the OK key.

### F3 - CURVE GRAPH – CURVE sub-menu

The CURVE sub-menu offers several tools which allow you to adjust the curve display and curve measurements.



CURVE sub-menu

Field	Description
TOOLS	The TOOLS sub-menu offers various tools for analyzing the measurement curves.
X/Y VIEW	The X/Y VIEW sub-menu allows you to designate a channel from a list of active channels as a data source. This channel is then used to represent the X axis.
GRID	The GRID sub-menu allows you to hide or display the grid lines for the curve graph.

## CURVE - TOOLS

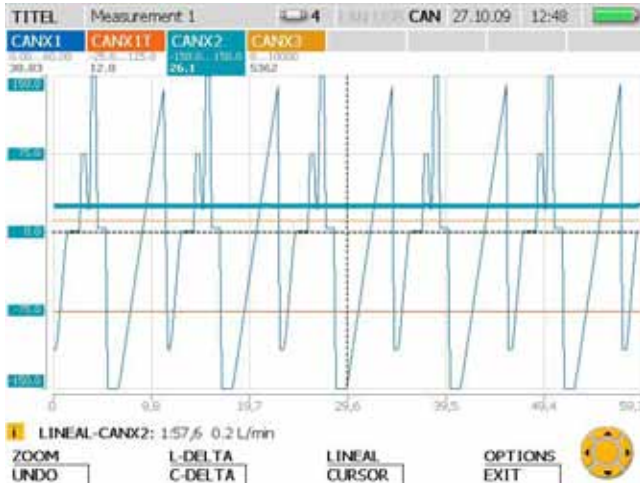

TOOLS window: View curve values and enlarge portions of the plotted curve

Field	Description
ZOOM	Press the F1 key to enlarge the curve within the ZOOM Details window.
UNDO	Press and hold the F1 key for two seconds in order to undo the previous zoom-in action. Press the F1 repeatedly until you are taken back to your desired view.
L-DELTA	Press the F2 key in order to compute the difference between any two points on the curve.
C-DELTA	Press and hold the F2 key for two seconds in order to compute the difference between two points on the selected measurement curve.
LINEAL	Press the F3 key in order to get the value for any point.
CURSOR	Press and hold the F3 key for two seconds in order to get the measurement value of a point on the curve.
OPTIONS	Press the F4 key to display the minimum or maximum values, or to activate and deactivate the grid lines.
EXIT	Press and hold the F4 key for two seconds to deactivate the analysis tool and return to the normal measurement view.





The values shown in the status bar of the tool window are relevant for the selected channel.



Specify a new position number if you would like to select another channel.

## CURVE - TOOLS - ZOOM sub-menu



ZOOM window: view an enlarged section of the curve

Field	Description
UNDO	Press the F1 key in order to undo the previous zoom-in action. Press the F1 repeatedly until you are taken back to your desired view.
RESET	Press and hold the F1 key for two seconds in order to undo all zoom-in actions.
RESIZE	Press the F2 key in order to change the size of the displayed section using the arrow keys.
MOVE	Press the F3 key in order to move the displayed section using the arrow keys.
ZOOM	Press the F4 key in order to enlarge the displayed section.
EXIT	Press and hold the F4 key for two seconds in order to exit from the Tools window.

**i** Use the OK key to enlarge the displayed section. This action is not dependent on the tool selected.

## CURVE - TOOLS - L-DELTA sub-menu

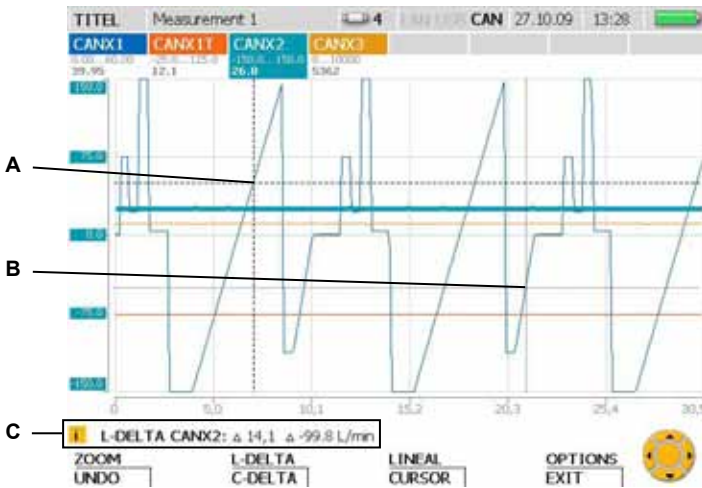

L-DELTA window: Calculate the difference

Field	Description
A	Point of intersection for the first cross-hairs (dashed = active). You can use the arrow keys to move the activated cross-hairs.
B	Point of intersection for the second cross-hairs. Press the OK key to activate these cross-hairs. (Press the OK key a second time to re-activate the first cross-hairs.)
C	Status bar which specifies the selected tool, the displayed channel and the difference between the intersection points.
UNDO	Press and hold the F1 key for two seconds in order to undo the previous zoom-in action. Press the F1 repeatedly until you are taken back to your desired view.
EXIT	Press and hold the F4 key for two seconds in order to exit from the Tools window.



Specify a new position number if you would like to select another channel.

## Menu Options

### CURVE - TOOLS - C-DELTA sub-menu

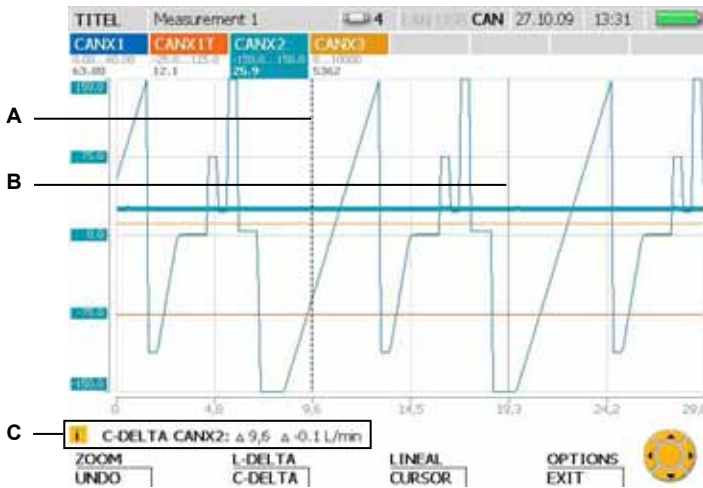

C-DELTA window: Calculate the difference between two measured values

Field	Description
A	First line (dashed = active). You can use the arrow keys to move the activated line.
B	Second line. Press the OK key to activate this line. (Press the OK key a second time to re-activate the first line.)
C	Status bar which specifies the selected tool, the displayed channel and the difference between the intersection point of the line and the curve.
UNDO	Press and hold the F1 key for two seconds in order to undo the previous zoom-in action. Press the F1 repeatedly until you are taken back to your desired view.
EXIT	Press and hold the F4 key for two seconds in order to exit from the Tools window.



Specify a new position number if you would like to select another channel.

## CURVE - TOOLS - LINEAL sub-menu

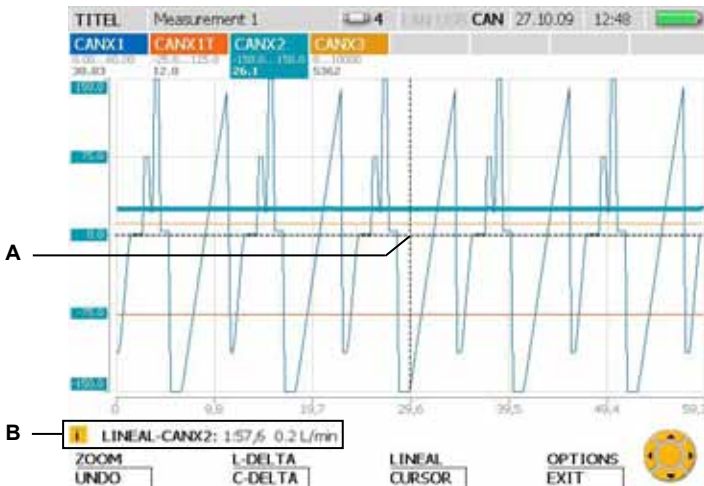

LINEAL window: Calculate the value at a specific coordinates point

Field	Description
A	Point of intersection for the cross-hairs. You can use the arrow keys to move the cross-hairs.
B	Status bar which specifies the selected tool, the displayed channel and the value at the cross-hairs intersection point.
UNDO	Press and hold the F1 key for two seconds in order to undo the previous zoom-in action. Press the F1 key repeatedly until you are taken back to your desired view.
EXIT	Press and hold the F4 key for two seconds in order to exit from the Tools window.



Specify a new position number if you would like to select another channel.

## Menu Options

### CURVE - TOOLS - CURSOR sub-menu

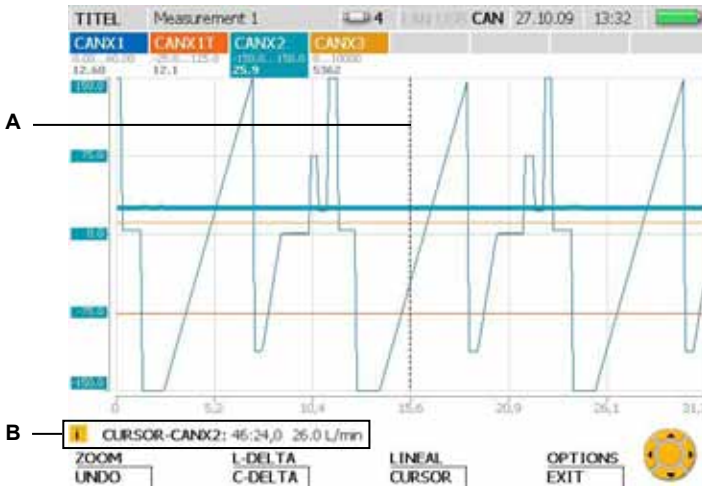

CURSOR window: Calculate the measured value

Field	Description
A	Line. You can use the arrow keys to move the line.
B	Status bar which specifies the selected tool, the displayed channel and the measured value at the intersection point of the line and the curve.
UNDO	Press and hold the F1 key for two seconds in order to undo the previous zoom-in action. Press the F1 key repeatedly until you are taken back to your desired view.
EXIT	Press and hold the F4 key for two seconds in order to exit from the Tools window.



Specify a new position number if you would like to select another channel.

**CURVE - TOOLS - OPTIONS sub-menu**

OPTIONS sub-menu: View the minimum/maximum values and the grid lines.

Field	Description
JUMP TO	Select the JUMP TO option in order to change to the minimum (MIN) or maximum (MAX) value.
CURVE GRAPH	Select CURVE GRAPH in order to toggle between the current measurement value view (ACT) or the minimum/maximum (MIN/MAX) values view.
GRID	This option allows you to display (ON) or hide (OFF) the background grid lines for the curve graph.

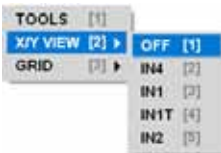

The minimum/maximum values are displayed in the status bar.

**CURVE - X/Y-VIEW sub-menu**

X/Y view sub-menu: Use the sensors as the data source for the X and Y axes.

Field	Description
OFF	Select OFF in order to go back to representing time on the X axis.
IN4, IN1, IN1T, IN2	Select a channel as the source for X-axis measurements.



The X/Y-VIEW sub-menu can be used, for example, for viewing a load characteristic curve (p/Q graph).

## Menu Options

### 8.3.6 VIEW menu - LOAD FILE sub-menu

Saved measurements can be located and opened in the LOAD FILE sub-menu. The files are sorted according to their measurement date. After being loaded, the measurement values are displayed as a plotted curve along with associated information.



LOAD FILE window

Field	Description
DEVICE	Display area for the storage medium. Select a storage type (flash device, SD card, USB flash drive).
A	Display area for the files. Select a file from the list shown.
FILE INFO	File information (name and date of measurement, file size, measurement type, number of channels, comments).
OPEN	Press the F1 or OK key in order to open the selected file.



### 8.3.7 VIEW menu - SENSOR INFO sub-menu

The SENSOR INFO sub-menu provides information about the connected sensors and ports. When this sub-menu is used to call up information about a particular CAN-bus sensor, an LED on the corresponding sensor will flash.



VIEW - SENSOR INFO window

Field	Description
CHANNEL	Designation of the active channel (input / output) for which information is being displayed.
NAME	Name of the channel for which information is being displayed.
SENSOR INFO	Sensor information for the selected channel (channel, name, type, unit, measurement range).



Use the arrow keys to select one of the displayed channels.

## Menu Options

### 8.4 F3 - RESET menu

You can reset the minimum and maximum values as well as the D-IN and D-OUT counters in the RESET menu. Offset values can be set for each channel in order to zero balance the measurement channels. This menu is not available while in the CURVE GRAPH view.



RESET menu

Field	Description
MIN/MAX	This function is used to reset the MIN and MAX values on all channels to the current measured value.
D-IN/OUT	This function is used to reset the counters for the digital inputs and outputs (D-IN, D-OUT) to zero.
ZERO INP	An offset calibration for a sensor/measurement channel can be performed in this sub-menu.
SET OFFSET	An offset calibration via a differential measurement on a calculating channel can be performed in this sub-menu.

#### 8.4.1 RESET menu - MIN/MAX sub-menu



MIN/MAX sub-menu

Field	Description
MIN/MAX	The MIN/MAX values of all channels are reset to the current measured value. The MIN/MAX value display starts over.



The MIN/MAX values are also reset when the instrument is turned on or when a new sensor is connected. It takes a few seconds after a sensor is connected for the measurements to stabilize and for the MIN/MAX values to be calculated. In REC mode, the MIN/MAX values are recorded continually (according to the specified recording rate).

### 8.4.2 RESET menu - D-IN/OUT sub-menu

D-IN/OUT [2] ▶ OK=RESET [1]

D-IN/OUT sub-menu

Field	Description
D-IN/OUT	The D-IN/D-OUT function is used to reset the counters for the digital inputs and outputs (D-IN, D-OUT) to zero.



The displayed event counters for D-IN and D-OUT are only recorded and saved in REC mode.

## Menu Options

### 8.4.3 RESET menu - ZERO INP sub-menu

The ZERO INP sub-menu can be used to perform an offset calibration using a zero-point measurement. Zero-point measurements are used to calculate a separate offset value for each channel. This is then used to adjust the measured values in the menu.



CHANNEL	NAME	ACTUAL	OFFSET	UNIT
IN1	VALVE P	0.2	6.5	bar
CAN0	PUMP	-1.3	0.0	l/min
CAN0	ENGINE	OFL	0	l/min

**i** ZERO INPUT: PRESS ENTER TO ZERO THE INPUT

CANCEL      SAVE      

RESET - ZERO INP window

Field	Description
CHANNEL	Channel designation and number.
NAME	Name of the channel.
ACTUAL	Current measured value. If the current value is $\geq \pm 2\%$ of the measurement range's end value, then the offset cannot be calibrated and the message OFL appears on the display.
OFFSET	Offset value. Press the OK key in order to reset the selected channel to zero. The offset value is displayed after the offset calibration is carried out.
UNIT	Displays the unit of measure.



The offset values are deleted when the measuring instrument is turned off. The offset value is zero when the instrument is turned on or when a new sensor is connected.

#### 8.4.4 RESET menu - SET OFFSET sub-menu

The SET OFFSET sub-menu can be used to perform an offset calibration using a differential measurement. A differential measurement from a second sensor is used to calculate a separate offset value for the first channel. This is then used to adjust the measured values in the menu.



RESET - SET OFFSET window

Field	Description
CHANNEL	Calculating channel designation and number.
NAME	Name of the calculating channel. All calculating channels that will have a reference (type difference) calculated are displayed.
ACTUAL	Current measured value. If the difference between the two sensors on the calculating channels is greater than 5% of the measuring range of the sensor with the largest measuring range, then the calibration cannot be carried out and the message OFL is displayed.
Δ OFFSET	Offset value. Press the OK key in order to reset the selected channel to zero. The offset value is displayed after the offset calibration is carried out.
UNIT	Displays the unit of measure.



The offset values are deleted when the measuring instrument is turned off. The offset value is zero when the instrument is turned on or when a new sensor is connected. If a sensor on a calculating channel is removed, then the offset value resets to zero and the values are not saved.

## Menu Options

### 8.5 F4 - REC menu

The REC menu allows you to select and adjust the type of measurement recording and also to initiate the measurement recording.



If another sensor is connected while a measurement recording is taking place, this additional sensor is ignored. The new sensor is not displayed as a new channel and its measurements are not recorded. The measurement process is continued even if a sensor is removed during the measuring.

START/STOP	[1]
POINT	[2]
TRIGGER	[3]
TRIGGER-LOGIC	[4]
PROJECT	[5]

REC menu

Field	Function
START/ STOP	The START/STOP function is used to initiate a continual non-triggered measurement. One of the display views (in the VIEW menu) is displayed. The measurement and all associated settings can be saved together as a project.
POINT	The POINT function is used to initiate a measurement. Individual measurements for each active channel are taken with the press of a button. One of the display views (in the VIEW menu) is displayed. The measurement and all associated settings can be saved together as a project.
TRIGGER	The TRIGGER sub-menu allows you to define a measurement that starts after a specified trigger signal is issued. This can then be saved as a project and started.
TRIGGER- LOGIC	The TRIGGER-LOGIC sub-menu can be used to define a measurement that is started and ended by a specified trigger signal. Logical operators between two trigger signals can also be used as the start and stop conditions. The measurement can then be saved as a project and started.
PROJECT	Project files can be selected and opened in the PROJECT sub-menu. A measurement can also be started and recorded according to the measurement type saved in the project file.



For measurements invoked from the REC menu, the following sub-menus are available: STATUS (displays measurement status information), SAVE PRJ (save settings for type of measurement).

- Addition information about point measurements can be found in the "Executing and saving measurements" section in the "Operations" Chapter.

### 8.5.1 STATUS sub-menu

The STATUS sub-menu is a sub-menu in the REC menu. It contains status and settings for the current measurement.

TITEL Measurement 1		
STATUS REC	ACTUAL	TOTAL
REC TIME	00:00:00	00:00:00
PRE TRIGGER	---	---
MEM REC	15216 PTS	18000 PTS
FREE MEM DEVICE		756138 PTS
DATA FORMAT		ACT/MIN/MAX
MEM FORMAT		2 ms
AUTO REPEAT		OFF
REC: LOGIC		START(A) STOP(C)
START A	●	WINDOW, CANX1, bar, 60, 30
STOP A	●	CLOCK, 28.10.09 11:20:00

REC: TRIGGER-LOGIC ● ESC=EXIT START=REC  
 BACK VIEW SAVE PRJ START ●

STATUS window (for example: a trigger-logic measurement)

Field	Description
REC TIME	Current and total recording time (maximum of 300 hours).
PRE TRIGGER	Current and total pre-trigger time (recording duration = pre-trigger time + measurement duration) for a triggered measurement.
MEM REC	Current and total recorded measurement points per channel.
FREE MEM DEVICE	Free memory, specified in number of available measurement points
DATA FORMAT	Memory storage type.
MEM FORMAT	Recording rate.
AUTO REPEAT	Automatic repeat of the triggered measurement (switched off in this example)
REC: LOGIC	Information about the type (trigger-logic measurement shown here) and status of the measurement. Yellow point: waiting for signal. Green point: measurement underway.
BACK	Press the F1 key to go back to the measurement display.
SAVE PRJ	Press the F3 key to display the SAVE PROJECT window. Here you can save the configuration of the sensors as a project.

## Menu Options

### 8.5.2 SAVE PRJ sub-menu

The SAVE PRJ sub-menu is a sub-menu in the REC menu. This sub-menu can be used to save relevant settings and measurement type information in a project file.

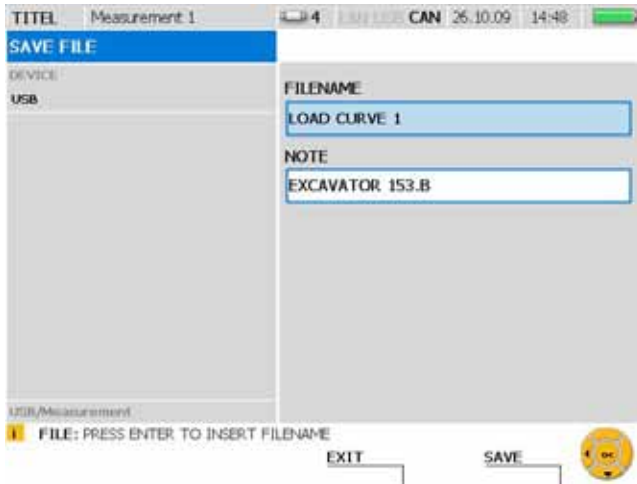

SAVE FILE window

Field	Function
TITEL	Title of the measurement.
DEVICE	Select a storage device type here.
FILENAME	Enter a file name.
NOTE	Specify a comment for the measurement.
EXIT	Press the F3 key in order to exit the window without saving your work.
SAVE	Press the F4 key in order to save the settings.



## 8.5.3 REC menu - TRIGGER sub-menu

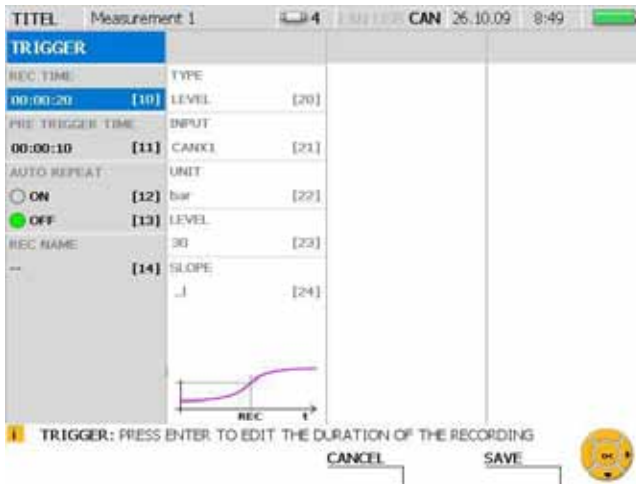

TRIGGER window

Field	Function
REC TIME	Specify the duration of the recording. The measurement recording can last up to 300 hours.
PRE TRIGGER TIME	Specify the duration of the pre-trigger time. The pre-trigger time must be shorter than the recording duration. (recording duration = pre-trigger time + measurement duration after the trigger signal).
AUTO REPEAT	Select ON here if you want the measurement to be automatically repeated.
REC NAME	Enter a file name. If AUTO REPEAT is set to ON, then a file name must be specified. The name can be no longer than 15 characters.
TYPE	Select the trigger type and the trigger parameters.



If the specified recording duration is larger than the maximum memory capacity, you will be asked to reduce either the recording duration or the recording rate.

- ▶ A more detailed description of triggered measurement is contained in the "Measurement Types and Memory Options" Chapter and in the "Executing and saving measurements" section in the "Operations" Chapter.

## Menu Options

### 8.5.4 REC menu - TRIGGER-LOGIC sub-menu

START CONDITION		STOP CONDITION	
A AND B	[10]	C AND D	[20]
TRIGGER A	TRIGGER B	TRIGGER C	TRIGGER D
TYPE	TYPE	TYPE	TYPE
LEVEL	[30] WINDOW	[40] CLOCK	[50] EXTERN
INPUT	INPUT	DATE	INPUT
CANX1	[31] CANX2	[41] 26.10.09	[51] D-IN
UNIT	UNIT	CLOCK TIME	SLOPE
bar	[32] 1/min	[42] 14:20:00	[52] ↓
LEVEL	UP LIMIT		
30	[33] 100	[43]	
SLOPE	LO LIMIT		
↓	[34] 50	[44]	

**TRIGGER-LOGIC: PRESS ENTER TO SELECT THE TRIGGER MODE**

CANCEL      SAVE

TRIGGER-LOGIC window

Field	Function
START CONDITION	Select a logical relation for the trigger connection (A, A AND B, A OR B).
STOP CONDITION	Select a logical relation for the trigger connection (C, C AND D, C OR D).
TRIGGER A - D	Select the trigger type and the trigger parameters.

- ▶ A more detailed description of trigger logic measurement is contained in the "Measurement Types and Memory Options" Chapter and in the "Executing and saving measurements" section in the "Operations" Chapter.





## 8.5.5 PROJECT sub-menu

CHANNEL	NAME	SET SENSOR	ACTUAL SENSOR	STATUS
CAN01	VALVE P	60 bar Ser.No. 945001617	60 bar Ser.No. 945001617	OK
CAN01T	VALVE T	150 °C Ser.No. 945001617	150 °C Ser.No. 945001617	OK
CAN02	ENGINE P	160 bar Ser.No. 945001720	160 bar Ser.No. 945001720	OK
CAN02T	ENGINE T	150 °C Ser.No. 945001720	150 °C Ser.No. 945001720	OK
CAN03	PUMP P	600 bar Ser.No. 945001823	600 bar Ser.No. 945001823	OK
CAN03T	PUMP T	150 °C Ser.No. 945001823	150 °C Ser.No. 945001823	OK

GREEN=CORRECT SENSOR, RED=WRONG SENSOR

REC PRJ      PC PRJ      EXIT

## LOAD PROJECT window

Field	Function
CHANNEL	Designation of the channel.
NAME	Name.
SET SENSOR	The channel's sensor type as specified in the project.
ACTUAL SENSOR	The connected sensor type.
STATUS	The status of the sensor channel. <ul style="list-style-type: none"> <li> OK The current sensor and the measurement range comply with the specified settings.</li> <li> RANGE The measuring range of the current sensor is greater than the preset measuring range.</li> <li> RANGE The measuring range of the current sensor is less than the preset measuring range.</li> <li>or</li> <li> SENSOR The current sensor type is not the same as the type specified in the project.</li> </ul>
REC PRJ	Press the F1 key in order to load the setting saved in the project.
PC PRJ	Press the F2 key to load the project settings and then wait for the communication link to be established to the PC (online project measurement).

## Menu Options

-  If a project is using analogue sensors without sensor-ID, then the sensor list will contain no entry for ACTUAL SENSOR. There will also be no color coding for compliant parameters.
- ▶ Addition information on the Project sub-menu can be found in the "Creating and loading projects" section in the "Operations" Chapter.



# Operations

Select the UNITS window.



Select SPEED

3 x



Change the unit of measurement for the speed.

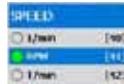
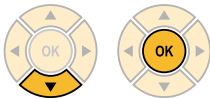

SAVE



Press the F4 key to save the changes made in the UNITS window.

CANCEL



Press the F3 key to delete the changes made in the UNITS window. The previous settings will then be restored.

### 9.1.2 Selecting the network connection

There are two possibilities for setting up a network connection between the measuring instrument and the PC. If you are using the PC analysis software, then the connection should be setup from within the analysis program. If you are using the remote maintenance function, then the connection should be setup on the instrument side using the PC remote display control program (CerDisp).

**i** Contact your network administrator if you are connecting and using the instrument in a corporate network or if you are experiencing a connection problem.

**i** It is not possible for the PC to establish contact with the measuring instrument during a measurement recording or during a FAST measurement.

You must know the instrument's network IP address if you want to setup a network connection. The network address can be automatically assigned (via DHCP) or entered manually, according to the method specified in the LAN SETTINGS sub-menu.

Open the LAN SETTINGS window.



Entry:  
51



Select MANUAL for IP-ASSIGNMENT if you want to specify the network address yourself.

Enter the network IP address given to you by your system administrator under the ADDRESSES field.

**i** Select DHCP for IP-ASSIGNMENT in the LAN SETTINGS window if you would like the IP address to be automatically assigned by the network router. The address assigned by the router will be shown in the ADDRESSES column.

## Operations

### Using the PC analysis software

The measuring instrument's address is recognized after you have set the network IP address as described above. This IP address should then be specified when setting up the connection using the PC analysis software program. The PC analysis software will control the measuring instrument and measurement will then be saved to the PC.

### Using the remote maintenance function

When using this function you must specify the IP address of the PC that you will be connecting to. This address must be specified for the CERDISP HOST setting on the measurement instrument. The CerDisp program should then be started on the PC. The remote maintenance connection is established after the START CerDisp function is started and set to ON.



You can then control the measurements using the PC simulation software or directly on the measuring instrument. It is possible to turn the measuring instrument on and off. Measurements are saved on the instrument.



If the connection to the PC is lost, you can end a running measurement process directly from the measuring instrument.





# Operations



Select the set point (PKT) and a value (4000 in this example).

2 x

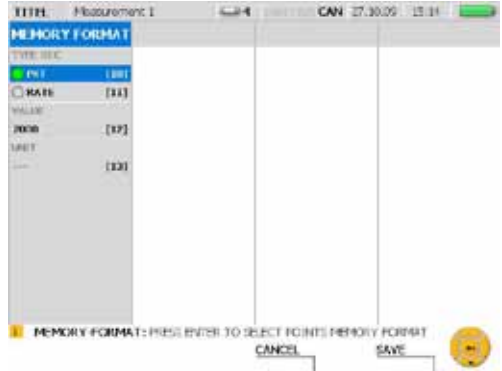

SAVE

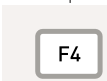

Press the F4 key to save the changes made in the MEMORY FORMAT window.

CANCEL



Press the F3 key to delete the changes made in the MEMORY FORMAT window. The previous settings will then be restored.

### 9.3 Sensor settings and information

When connecting and configuring sensor, you should be aware of the different sensor types and connection types:

- Sensors with automatic sensor-ID: CAN-bus sensors and analogue sensors with automatic sensor-ID.
  - Sensors without sensor-ID: A direct connection to a signal transmitter issuing current or voltage signals. This uses a current/voltage converter and connects via the D-IN/OUT port.
- ▶ The settings methods within the SENSOR menu are described in the "Main menu" section of the "Menu Options" Chapter.
- ▶ The "Connecting Inputs and Outputs" Chapter describes how to connect the sensors.

The measuring instrument automatically detects the parameter values of those sensors with sensor-ID functionality. No additional configuration is necessary.

Sensors without sensor-ID functionality can be connected directly to an input module on the measuring instrument. The connection can be either direct (to IN4/5/9/10) or via a current/voltage converter (to IN1/2/3/6/7/8). The parameter values should be specified in the SENSOR menu before connecting such sensors.



If the sensor has an external power supply, then the sensor should first be connected to the instrument and then to its power supply.

#### 9.3.1 Changing the configuration of an analogue sensor

The following example uses multiple menus to open the sensor configuration window from the main menu. There you can change parameters associated with an analogue sensor.

Invoke the main menu.

MENU

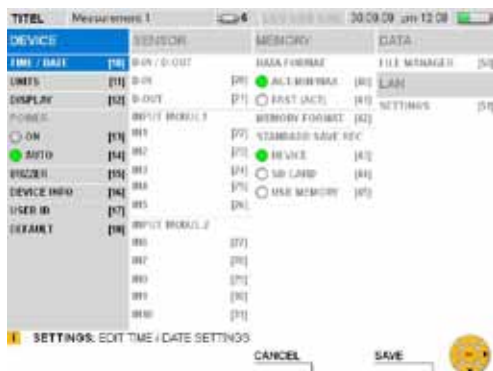

# Operations

Select a sensor input (IN9 in this example) at INPUT MODUL 2 from the SENSOR menu.

10 x

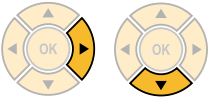

The INPUT:IN9 window is then displayed.



Activate the channel.



Select MANUAL in order to specify a unit of measure.



Specify a unit of measure.

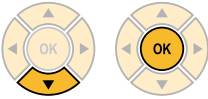

Enter:  
MM



Specify the minimum value on the scale.

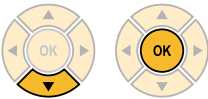

Enter:  
6000



Specify the maximum value on the scale.

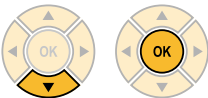

Enter:  
10000

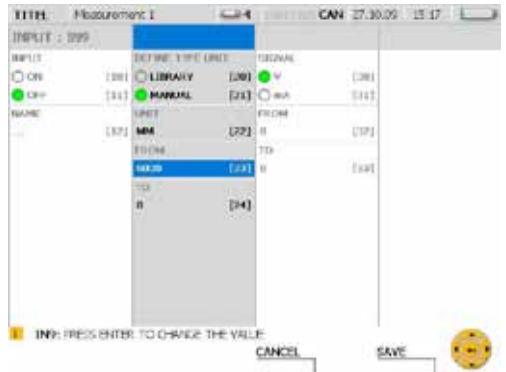
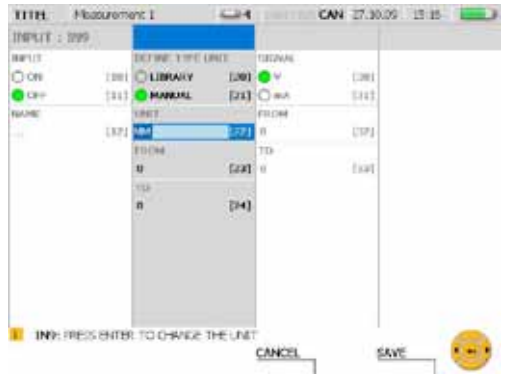

# Operations

Specify the maximum voltage value (10 volts in this example).

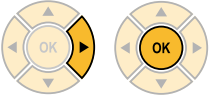

Enter:  
10



Specify the minimum voltage value (0 volts in this example).

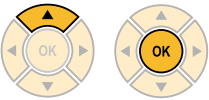

Enter:  
0



SAVE

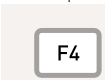

Press the F4 key to save the changes made.

CANCEL



Press the F3 key to delete the changes made. The previous settings will then be restored.

## 9.4 Executing and saving measurements

In addition to start/stop measurements, this instrument has three additional measurement functions (point, trigger and trigger logic) which allow you to specify a wide variety of measurement requirements.

The start/stop measurement function can be executed without any configuration. It enables very long measurement durations at high recording rates.

- ▶ The "Quick-start Measurements" Chapter contains more information about the start/stop measurement function.

Point measurements are activated by pressing a key. A single value is then measured on all active channels. Up to 999 points can be saved.

Starting conditions must be specified for a triggered measurement. The measurement process then starts when the specified condition is met. For example, if the LEVEL trigger type is selected, the measurement starts after the measured value reaches a specified threshold level. It is also possible to configure a pre-trigger duration. This enables measured values to be saved even before the trigger condition has been met. Additional trigger types include WINDOW, CLOCK, EXTERN and MANUAL. The measurement can be ended manually or after a specified time duration.

A trigger-logic measurement has both start and stop conditions. It uses the same trigger types for the start condition as the triggered measurements. Trigger types for the stop condition include WINDOW, CLOCK, EXTERN as well as TIME for specifying the measurement duration. Up to two conditions can be specified for both the start and the stop of the measurement. The two conditions can be logically connected with Boolean operators (AND or OR).

- ▶ Additional information about the measurement process can be found in the "REC menu" section of the "Menu Options" Chapter.
- ▶ Additional information on measurement specifications can be found in the "Technical Specifications" Chapter.



A sensor that is connected while a measurement is being recorded is not taken into consideration. So the measurement values from a new sensor would not be saved.

The measurement process is continued even if a sensor is removed during the measuring.

- ▶ Further information about memory option specifications can be found in the "Memory options" section in the "Measurement Types and Memory Options" Chapter.

## Operations

### 9.4.1 Executing a point measurement

The following example shows the menu navigation required for a point measurement.

Connect the sensors.

- ▶ The "Connecting Inputs and Outputs" Chapter describes how to connect the sensors.

Turn on the measuring instrument.

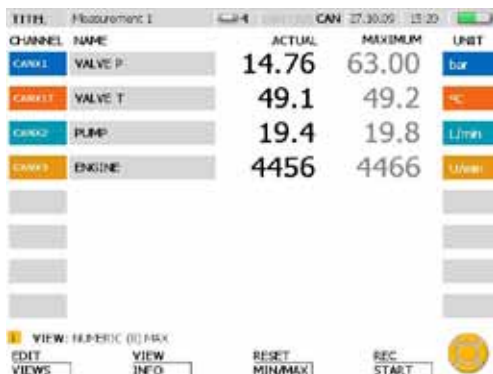

CHANNEL	NAME	ACTUAL	MAXIMUM	UNIT
CAN01	VALVE P	14.76	63.00	bar
CAN01 T	VALVE T	49.1	49.2	°C
CAN02	PUMP	19.4	19.8	L/min
CAN03	ENGINE	4456	4466	L/min

VIEW: NUMERIC (0) MAX  
EDIT VIEWS VIEW INFO RESET MIN/MAX REC START

Open the REC menu.

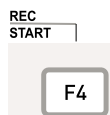

START/STOP	[1]
POINT	[2]
TRIGGER	[3]
TRIGGER-LOGIC	[4]
PROJECT	[5]

Select point measurement.



CHANNEL	NAME	ACTUAL	MAXIMUM	UNIT
CAN01	VALVE P	30.75	63.00	bar
CAN01 T	VALVE T	49.1	49.2	°C
CAN02	PUMP	19.5	19.8	L/min
CAN03	ENGINE	4456	4466	L/min

REC-POINT NO. 001 ESC = EXIT START = REC  
STATUS VIEW SAVE PROJ START



Start the point measurement.

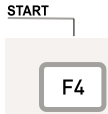

The message REC flashes in the status bar after the measurement has started.

CHANNEL	NAME	ACTUAL	MAXIMUM	UNIT
CAWX1	VALVE P	16.43	16.47	bar
CAWXT1	VALVE T	16.1	16.1	°C
CAWQ1	PUMP	128.5	128.9	L/min
CAWY1	ENGINE	5362	5372	U/min

POINT NO. 007 ESC = EXIT START = REC  
 STATUS VIEW STOP START

Specify additional measurement points.

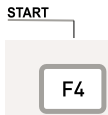

An additional point is saved each time you press the F4 key.

The number shown after POINT NO in the status bar specifies the number of saved points. Up to 999 points can be saved.

CHANNEL	NAME	ACTUAL	MAXIMUM	UNIT
CAWX1	VALVE P	16.43	16.47	bar
CAWXT1	VALVE T	16.0	16.1	°C
CAWQ1	PUMP	128.3	128.9	L/min
CAWY1	ENGINE	5359	5372	U/min

POINT NO. 008 ESC = EXIT START = REC  
 STATUS VIEW STOP START

# Operations

## 9.4.2 Selecting a trigger type and configuring parameters

The following example shows the menu navigation required for selecting a trigger type and configuring the parameters.

Open the REC menu.

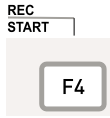

Select the TRIGGER menu and specify the duration of the measurement recording (1 hour and 23 minutes in this example).

2 x

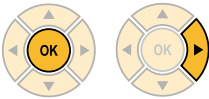
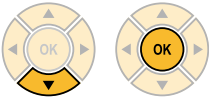

Enter:  
123

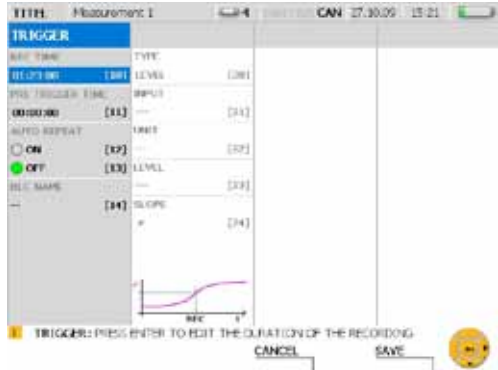

Specify the pre-trigger time (15 minutes and 30 seconds in this example).

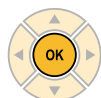
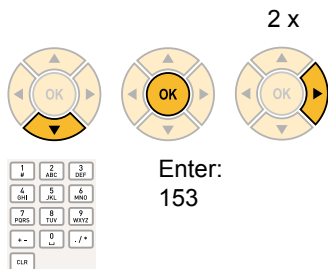

Open the TYPE menu and select a trigger type (for example, WINDOW).

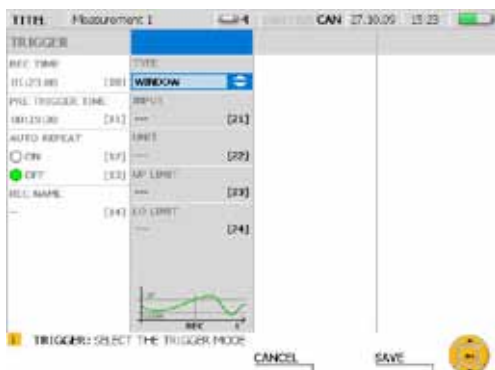
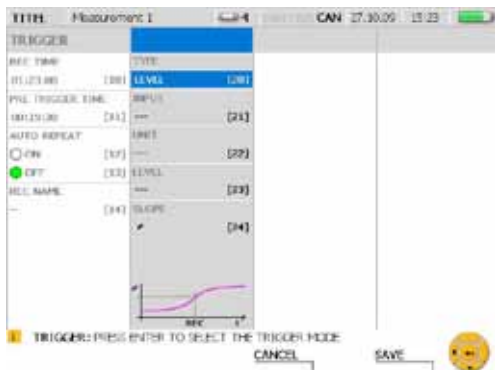
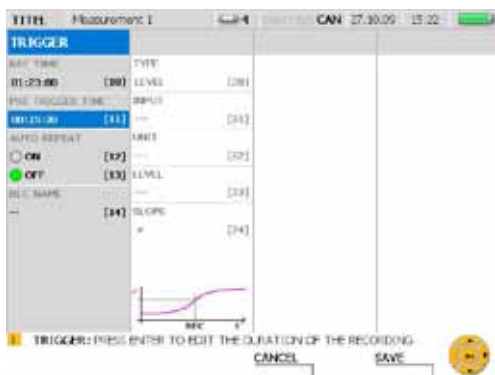

# Operations

The following parameters can be specified for the WINDOW trigger type:

- Channel selection
- Upper limit for window
- Lower limit for window

If the upper or lower limit is passed, then the trigger condition has been met and the measurement starts.

Select the trigger condition UP LIMIT (70 bar in this example).

3 x

Enter:  
70

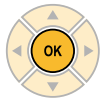

Select the trigger condition LO LIMIT (5 m in this example).

Enter:  
5

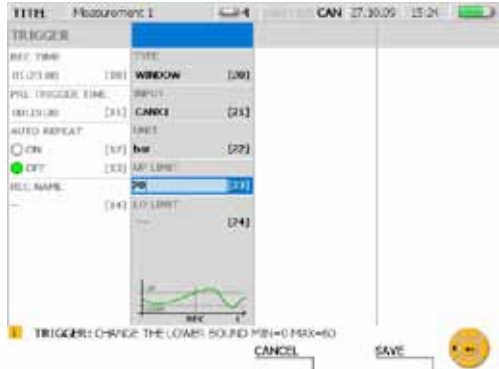
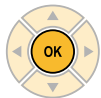

SAVE



Press the F4 key to save the changes made in the REC TRIGGER window.

CANCEL



Press the F3 key to delete the changes made in the REC TRIGGER window. The previous settings will then be restored.

# Operations

## 9.4.3 Starting and stopping triggered measurements

The following example shows the menu navigation required for executing and saving a triggered measurement.

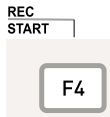

Enter:  
3

- ▶ The previous section "Selecting a trigger type and configuring parameters" describes the configuration process.

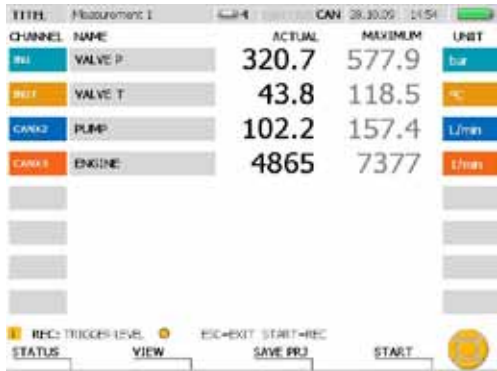
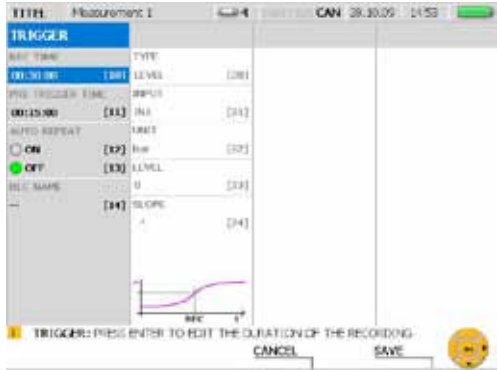

START



The message REC flashes in the status bar after the triggered measurement has started. A yellow point appears in the status bar and the instrument waits for the trigger signal.

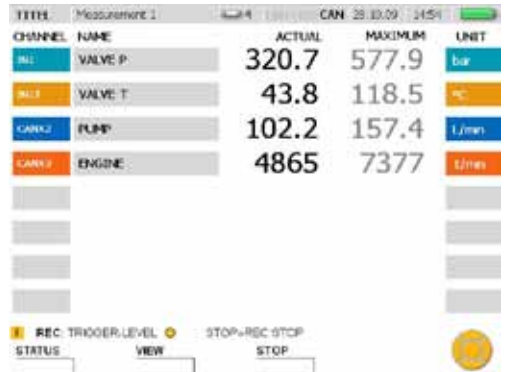

A green point appears in the status bar after the instrument has received the trigger signal and the measurement has begun.



You can switch the way the measured values are displayed while the measurement is being carried out.

Measurement information can be viewed in the STATUS window.

STATUS



## Operations

Press the F1 key (BACK) again to go back to the measurement display.

Wait until the measurement duration has expired. You can also press the F3 key to terminate the measurement before the specified duration.

STOP

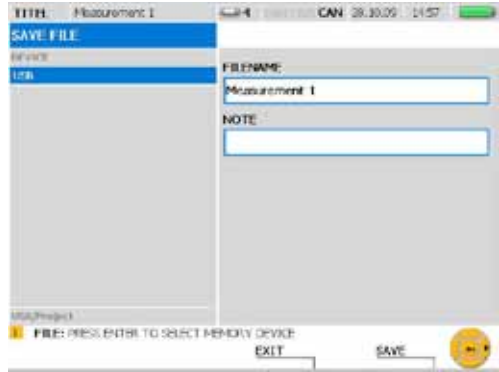

Enter a file name under FILENAME. The name can be no longer than 16 characters.

Enter an optional comment in the NOTE field. The comment can be no longer than 200 characters.

SAVE



Press the F4 key to save the changes made in the SAVE FILE window.

EXIT



Press the F3 key to delete the changes made in the SAVE FILE window. The previous settings will then be restored.

► Further information about memory option specifications can be found in the "Measurement Types and Memory Options" Chapter.



During the save process, measured values are compressed to optimize memory use. This can take several seconds.



## 9.5 Creating and loading projects

You can save the instrument's settings in a project in order to use the same configuration in other measurement processes. The saved project can then be loaded to continue measurements with the same sensors and sensor settings. The following configuration information is saved in a project:

- Sensor type and measurement range
- Channel name
- Instrument port for the sensor
- Display properties
- Measurement type and trigger parameters
- Instrument settings such as unit of measure and measurement data formats

For the digital channels (D-IN and D-OUT), the current sensor port is displayed and the trigger and slope settings are saved.

You can save a project in the SAVE PROJECT window before starting the measurement. You can also create a project from a previously executed measurement with the PC analysis software.

 The manual for the PC analysis software contains more information about creating a project with the PC software.

The following example shows the menu navigation required for loading a project and starting a measurement.

Open the LOAD PROJECT window.

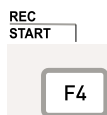

Enter:  
5



## Operations

Connect the individual analogue sensors. When measuring with CAN-bus sensors, connect the cable with the connected CAN sensors to the measuring instrument. You can use the LOAD PROJECT window to compare the sensor channels as they should be and as the actually are.

The following is displayed:

- The channel name
- The channel's sensor type (SET SENSOR) as specified in the project
- The sensor actually connected on the channel (ACTUAL SENSOR)
- The status of the sensor channel

CHANNEL NAME	SET SENSOR	ACTUAL SENSOR	STATUS
VALVE P	60 bar	60 bar	OK
VALVE T	150 °C	150 °C	OK
ENGINE P	150 bar	150 bar	OK
ENGINE T	150 °C	150 °C	OK
PUMP P	600 bar	600 bar	OK
PUMP T	150 °C	150 °C	OK

GREEN-CORRECT SENSOR, RED-WRONG SENSOR

REC PRJ PC PRJ EXIT

After each sensor connection you should check that the connection is functional and that the proper sensor is connected.



The PC PRJ function (the F2 key) is used to prepare the instrument for a PC-online project measurement. It loads the invoked project. If you press the F2 key, the instrument will then wait for a signal from the PC analysis software to start the measurement.

The project's sensor list has a colored status field which shows if the specified parameters comply with the corresponding sensor.

Color	Description
OK	The current sensor and the measurement range comply with the specified settings.
RANGE	The measuring range of the current sensor is greater than the preset measuring range.
RANGE	The measuring range of the current sensor is less than the preset measuring range.
SENSOR	Or the current sensor type is not the same as the type specified in the project.



If a project is using analogue sensors without sensor-ID, then the sensor list will contain no entry for ACTUAL SENSOR. There will also be no color coding for compliant parameters.

Load the settings from the saved project.

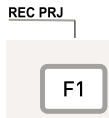

CHANNEL	NAME	ACTUAL	MAXIMUM	UNIT
CAN01	VALVE P	30.02	63.00	bar
CAN02	VALVE T	90.2	90.3	°C
CAN03	ENGINE P	11.9	11.9	bar
CAN04	ENGINE T	-13.9	-13.9	°C
CAN05	PUMP P	308.6	309.0	bar
CAN06	PUMP T	52.2	52.2	°C

REC: START/STOP ESC - EXIT START - REC  
 STATUS VIEW SAVE PRJ START

Start the measured from the saved project.

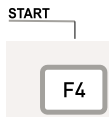

The project can still be loaded even when the parameters specified in the sensor list do not comply with the connected sensors.

# Operations

## 9.6 Loading and analyzing saved measurements

Saved measurements can be analyzed on the instrument itself or in the PC analysis software. The instrument's analysis features include minimum/maximum deviation analysis, system analysis or search for pressure peaks. Sections of the plotted measurement curve can be enlarged. Individual values and value deviations can also be viewed. A more detailed analysis can be carried out on the PC with the analysis software.

- ▶ The manual for the PC analysis software contains more information about analyzing saved measurements with the PC software.
- ▶ Additional information about the instrument's analysis features can be found in the "VIEW menu - CURVE sub-menu" section of the "Menu Options" Chapter.

The following example shows the menu navigation required for analyzing a curve and determining measured value deviations.

Open the LOAD FILE window.

VIEW

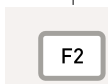

Enter:  
6



Select the saved measurement that you wish to analyze.

OPEN



During the save process, measured values are compressed to optimize memory use. It can therefore take several seconds to load a measurement.

Open the TOOLS window.

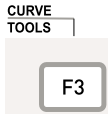

Press for two seconds.



Open the ZOOM window.

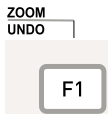

Use the arrow keys to select the portion of the image that you wish to enlarge.

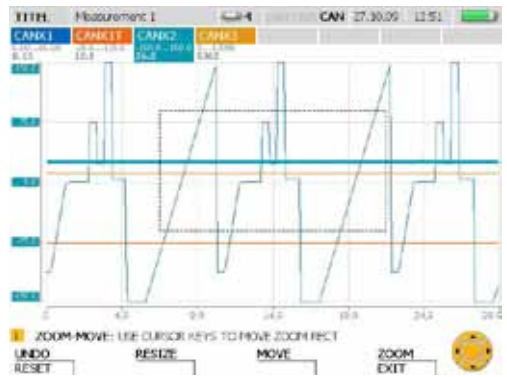

Exit the window.

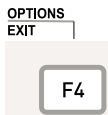

Press for two seconds.

- ▶ Additional information about the ZOOM function features can be found in the "VIEW menu - CURVE sub-menu" section of the "Menu Options" Chapter.

## Operations

Multiple types of analysis can be executed from the CURVE GRAPH window. The following example shows how to determine the deviation between two measured values.

Open the C-DELTA window.

L-DELTA  
C-DELTA

F2

Press for two seconds.

The left cursor line is highlighted with a bold dashed line. The first measured value is the value at the intersection of this line and the plotted measurement curve.

Use the arrow keys to move the cursor line. Move the line until you reach the first measured value for basing the deviation calculation.



Activate the right cursor line.

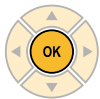

The right cursor line is highlighted with a bold dashed line. The second measured value is the value at the intersection of this line and the plotted measurement curve.

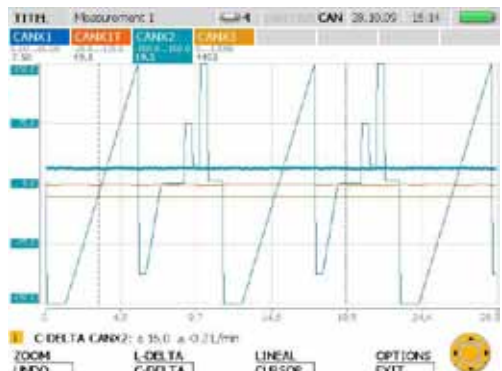
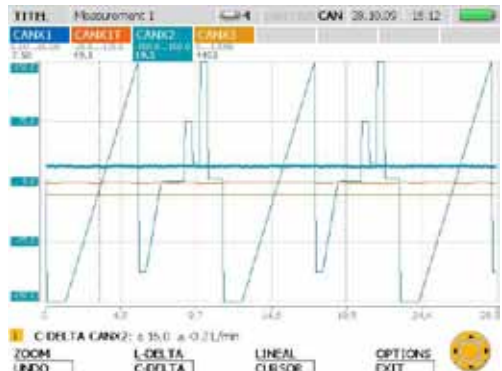

Use the arrow keys to move the right cursor line. Move the line until you reach the second measured value for basing the deviation calculation.



The calculated deviation (difference) for the measurement time and values is then displayed and updated constantly in the status bar.

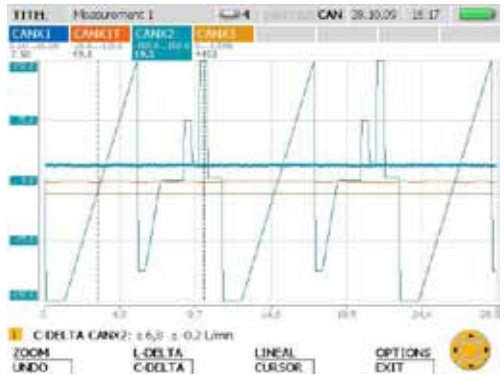

Close the C-DELTA window.

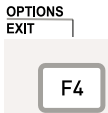

Press and hold for two seconds.

### 10 Measurement Types and Memory Options

#### 10.1 An explanation of measurement types

##### Start/stop measurement

The start/stop measurement function can be used without making any configuration changes. This type of measurement records the current, minimum and maximum measured values for each measurement channel. The measurement can be any duration since the data is compressed as it is saved on the fly.



During compression, the pressure peak information is not lost since the minimum and maximum measured values are also saved.

##### Point measurement

Current measured values are saved (one value per channel) each time the START key is pressed during a point measurement. Up to 999 points can be recorded per channel.



The type of measurement is well suited for displaying the power of a hydraulic pump (with a p-Q graph).

##### Triggered measurement

A specific start condition is defined to trigger this type of measurement. The measurement then starts and runs for a specified duration. The start condition (a trigger event) could occur, for example, when a measurement is below or above a certain limit value, or when an external digital signal is received. A pre-trigger time can be specified so that measured values can be recorded before the trigger event occurs. A triggered measurement can last up to 300 hours. This type of measurement records the current, minimum and maximum measured values for all channels.



### Trigger-logic measurement

A trigger-logic measurement is started after one or two start conditions are met. These conditions can be logically linked to each other with Boolean operators (AND and OR). The measurement process ends after one or two linked stop conditions are met. The process can also be terminated after a specified duration. The start/stop conditions could occur, for example, when a measurement is below or above a certain limit value, or when an external digital signal is received. The duration of the measurement is not limited since measurement data is compressed as it is being saved. This type of measurement records the current, minimum and maximum measured values for all channels. The pressure peak information is not lost.



If two start or stop conditions are linked with AND, then both conditions must not occur simultaneously. The two AND-linked conditions must occur sequentially in order to be considered a trigger event.

### 10.2 Notes on triggered and trigger-logic measurements

Start/stop conditions must be specified for triggered measurements and trigger-logic measurements. This section describes conditions which can be set to control the start and stop of a measurement recording process.



In order to select the start/stop conditions, open up the TRIGGER or TRIGGER-LOGIC sub-menu from the REC menu.

- ▶ The "REC menu" section in the "Menu Options" Chapter describes the REC menu. The menu navigation required for selecting and configuring parameters in triggered measurements is described in the "Executing and saving measurements" section in the "Operations" Chapter.

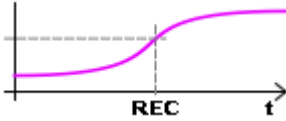
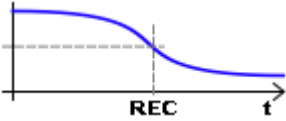
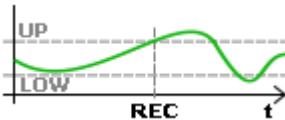
Start/stop measurement	Explanation
LEVEL	<p data-bbox="303 204 992 341">If a measurement exceeds or falls below a specific limit, then the measurement recording begins. Select a channel (INPUT) and a limit (LEVEL). Then specify a rising or falling slope (SLOPE). The specified limit must lie within the measuring range of the selected channel.</p> <div data-bbox="303 368 953 555"><p data-bbox="303 368 471 394">Exceeding limit:</p><p data-bbox="659 368 857 394">Falling below limit:</p></div> <p data-bbox="303 584 627 839">If the measurement process is started while the measured value for the selected channel exceeds the specified limit, then the measurement will not be started until at least one of the measured values falls below the limit and then exceeds it once again.</p> <p data-bbox="659 584 983 839">If the measurement process is started while the measured value for the selected channel is below the specified limit, then the measurement will not be started until at least one of the measured values is above the limit and then falls below it once again.</p>
WINDOW	<p data-bbox="303 866 992 1031">If a measurement exceeds or falls below a specific range, then the measurement recording begins. Select a channel (INPUT) and an upper (UP) and lower (LOW) limit for the measuring range. The specified limits must lie within the measuring range of the selected channel. The upper limit must be greater than the lower limit.</p> <div data-bbox="309 1066 594 1185"></div> <p data-bbox="303 1206 975 1343">If the initial measured value from the channel (at the start of the measurement process) is outside of this window, then no measurements will be saved. The recording of the measurements first begins after the measurements fall within the specified range (window) and then leave this range.</p>

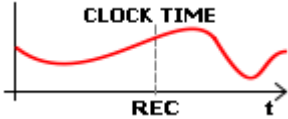
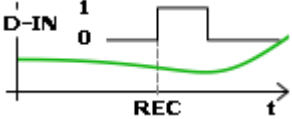
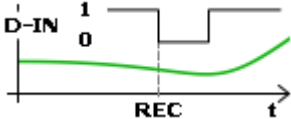
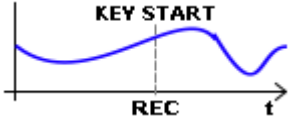
Start/stop measurement	Explanation
<p>CLOCK</p>	<p>The measurement is started at the specified date and time. Enter a date (DATE) and time (CLOCK TIME) for the start condition. The specified time must be in the future; it uses the instrument's system time as a reference.</p> 
<p>EXTERN</p>	<p>The measurement recording is started when a rising or falling slope is applied to the digital input. The direction of the slope (SLOPE) should be specified.</p> <p>Rising slope: (signal changes from LOW to HIGH)</p>  <p>Falling slope: (signal changes from HIGH to LOW)</p>  <p>If a HIGH signal is already applied to the digital input, then at least one slope change must take place before the recording of measurements will begin.</p> <p>If a LOW signal is already applied to the digital input, then at least one slope change must take place before the recording of measurements will begin.</p>
<p>MANUAL (Start only)</p>	<p>The measurement process starts when the F4 key is pressed. No other configuration is required.</p> 

## Measurement Types and Memory Options

Stop condition	Explanation
TIME	The measurement process is ended when the specified duration has elapsed since the start. Specify a measurement duration (REC TIME) for a stop condition or for a trigger-logic measurement.

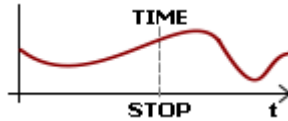

The following table shows the configuration options available in the TRIGGER and TRIGGER-LOGIC sub-menus.

Trigger type	Parameter field	TRIGGER sub-menu	TRIGGER-LOGIC sub-menu
LEVEL	Channel selection, unit of measure, trigger level, slope	X	X
WINDOW	Channel selection, unit of measure, upper and lower limit for the window	X	X
CLOCK	Trigger date, trigger time, a.m/p.m	X	X
EXTERN	Channel selection, slope	X	X
MANUAL	Start condition	X	(only available as START CONDITION)
TIME	Duration of measurement	–	(only available as START CONDITION)

### 10.3 Memory options

#### 10.3.1 Configuring the measurement data format

The instrument samples all connected sensors and channels simultaneously using a high polling rate (0.1 ms or  $\geq 1$  ms). There are two possibilities:

- ACT/MIN/MAX: Polling rate  $\geq 1$ ms
- FAST (ACT): Polling rate = 0.1ms

The measured values are saved according to the configuration specified in the MEMORY FORMAT sub-menu (under the MEMORY menu).

Despite the high polling rate, all ACT/MIN/MAX measured values are saved in compressed format. The ACT (current) value is the last sample value on a sensor within a particular recording interval. The MIN value is the lowest measured value sampled in a particular recording interval. The MAX value is the highest measured value sampled in a particular recording interval.

	Format	Description
In the DATA FORMAT sub-menu, select	ACT/MIN/MAX (Standard)	The current (ACT) measurement, minimum (MIN) measurement and maximum (MAX) measurement values are saved within a specified recording interval (configured in the MEMORY FORMAT menu).
	FAST (ACT)	The channels IN4 and IN9 of the optional model-01 input modules are sampled and ACT (current) values are saved at a fixed interval of 0.1 ms. No other channels are measured and recorded during this time. This type of measurement can only be used for a triggered measurement (and not a trigger-logic measurement). The measurement can take place for no more than 120 seconds.

### 10.3.2 Configuring the recording of measurements

There are three variants for recording measured values on the instrument:

- Point measurements (2000, 4000, 8000, 16000)
- Recording rate (1 ms to 60 min)
- Dynamic (16000 points)

As explained below, these settings must be made in conjunction with the ACT/MIN/MAX selection (in the DATA FORMAT sub-menu under the MEMORY menu).

The instrument has a maximum of 16000 measurement points available for each channel, regardless of the number of sensors connected. A measurement point consists of three values: an ACT value, a MIN value and a MAX value. The following configuration options are available in the MEMORY FORMAT sub-menu: The PKT settings allows you to change the number of measurement points. The RATE setting allows you to specify a recording rate anywhere between the set limits.

	Memory format	Description
In the MEMORY FORMAT sub-menu, select	Measurement points (2000, 4000, 8000, 16000)	The selected recording time is automatically divided into a fixed number of recording intervals per channel and number or selected points. <b>For example:</b> Points selected = 4000 Recording time: 10 min = 600 s Duration of the recording interval = $600 \text{ s} / 4000 = 150 \text{ ms}$ The ACT, MIN and MAX values are recorded for each channel for a duration of 150 ms.
	Recording rate (1 ms to 60 min)	A recording interval is specified here. This is the rate at which measurement points are recorded for each channel. <b>For example:</b> Recording rate selected = $10 \text{ ms} = 0.01 \text{ s}$ $16000 \text{ points} * 0.01 \text{ s} = 160 \text{ s}$ The recording can last for a duration of 160 seconds (with a 10-ms recording rate), regardless of the number of connected channels. The ACT, MIN and MAX values are recorded for each elapsed recording interval.

	Memory format	Description
No selection: automatically configured depending on the measurement options selected.	Dynamic (16000 points)	The in-process compression of measured values and adjustment of the recording interval starts at 1 ms. The recording interval is doubled after the limit has been reached for the measurement recording (16000 points per channel). Measurements of unlimited duration are possible. Also features optimized recording intervals and recording of ACT, MIN and MAX values.

### 10.3.3 Selecting DATA FORMAT = ACT/MIN/MAX

The following table illustrates the relationship between measured value recording and the different recording options.

Measured value recording	Points	Recording rate	Dynamic
Start/stop measurement	--- Not possible	--- Not possible	16000 points per channel, unlimited measurement duration
Point measurement	ACT value with press of key. Max. 999 values per channel.	--- Not possible	--- Not possible
Triggered measurement	2000, 4000, 8000, 16000 measurement points per channel	Can be configured anywhere from 1 ms to 60 minutes. Max. 16000 measurement points per channel.	--- Not possible
Trigger-logic measurement	--- Not possible	--- Not possible	16000 measurement points per channel, unlimited measurement duration

## Measurement Types and Memory Options

### 10.3.4 Selecting DATA FORMAT = FAST (ACT)

If FAST (ACT) is selected, only the triggered measurement type is available for recording measurements.

Measured value recording	Points	Recording rate	Dynamic
Triggered measurement	--- Not possible	0.1 ms. Max. 1,200,000 measured values each for IN4 and IN9.	--- Not possible



## 11. Maintenance and cleaning

### 11.1 Notes on cleaning



#### ATTENTION

Be sure to turn off the instrument and disconnect the power supply before you start cleaning it.



#### ATTENTION

Never use aggressive cleaning agents, solvents, petroleum ether or similar chemicals. These chemicals can damage the housing or display on the instrument.

Clean the instrument's housing with a soft moist cloth. Mild household cleaners may be used for hard-to-remove dirt and debris.

### 11.2 Notes on maintenance and calibration

This measuring instrument requires no special maintenance. However, it is necessary to calibrate the instrument regularly. A yearly calibration procedure is required if you use the instrument often. Please contact your sales representative for more information.

### 11.3 Repairs

Contact your sales representative if your instrument needs repairs. Have the following information ready:

- The name of your company or organization
- The name of your department
- Your contact person
- Your telephone and fax number
- Your e-mail address
- The article number of the faulty instrument (and serial number, if available).
- A detailed description of the problem

## 12. Accessories

### 12.1 General accessories

<b>Power supply unit</b> 110/240 VAC EUR/US/UK/AUS	SR-PSU-HPM6000
<b>Neck strap</b>	SR-HPM6000-00-0C-STP
<b>Cable adapter, M8x1</b> for D-IN/OUT	SR-CONN-ADPT-M8
<b>Sensor adapter, M12x1</b> for external sensors	SR-CONN-ADPT-M12
<b>Frequency adapter (2 Hz – 5 kHz)</b> including M8x1 cable adapter with analogue and CAN-bus interface	SR-FQC
<b>Current/voltage converter (0–48V, 0–4A)</b> including connection cable with test terminal	SR-VADC-1C

### 12.2 Analogue sensors (with automatic sensor-ID) and connecting cable

<b>Analogue connection cable</b> 3 m 5 m Extension (5 m)	SR-CBL-003-55-MM SCK-102-05-02 SCK-102-05-12
<b>Pressure/temperature sensor</b> -25 to +105 °C, including mounted SCA-1/2-EMA-3 adapter Choose 15, 60, 150, 400, 600, 1000 bar ranges	SR-PTT-XXX-05-0C
<b>Temperature sensor (-25 to 125 °C)</b>	SR-TTP-400-05-0C
<b>Tachometer (0 to 10,000 RPM)</b> with 2 metres attached cable	SR-RPN-300-05-3C
<b>Flow turbine</b> 015/060/150/300/600/750 L/min	CTXXX-SR-B-B-X
<b>Flow turbine with load valve</b> 300/600/750 L/min	CTXXXR-SR-B-X

## 12.3 CAN-bus sensors (with intelligent digital) and connecting cable

<b>CAN connection cable</b> 0.5 m 2 m 5 m 10 m 20 m	SR-CBL-0.5-MF-CAN SR-CBL-02-MF-CAN SR-CBL-05-MF-CAN SR-CBL-10-MF-CAN SR-CBL-20-MF-CAN
<b>CAN Y splitter,</b> including 0.05 m cable including 0.3 m cable	SR-CBL-0.05-Y-CAN SR-CBL-0.3-Y-CAN
<b>CAN terminating resistor</b> Female 5-pin socket – female 5-pin socket	SR-CBL-000-R-CAN
<b>Pressure/temperature sensors</b> -25 to +125 °C, including mounted SCA-1/2-EMA-3 adapter -1 to 16 bar 060/160/400/600/1000 bar	SR-PTT-016-05-0C-CAN SR-PTT-XXX-05-0C-CAN
<b>Flow turbine</b> 015/060/150/300/600/750 L/min	CTXXX-CAN-X-X-X
<b>Flow turbine with load valve</b> 300/750 L/min	CTXXXR-CAN-X-X-X

### 13. Technical Specifications

#### 13.1 Base instrument and options

Instrument	Ports	Max. number of sensors	Max. number of channels	Polling rate
SR-HPM-6016-05-0C-CAN (Base unit)	2 CAN-bus networks	8 CANX	16	≥ 1 ms
		8 CANY	16	≥ 1 ms
	1 D-IN	1 D-IN	1	1 ms
	1 D-OUT	1 D-OUT	1	1 ms
SR-HPM-6116-05-0C-CAN (Base unit + 1 model-01 input module)	2 CAN-bus networks	8 CANX	16	≥ 1 ms
		8 CANY	16	≥ 1 ms
	1 D-IN	1 D-IN	1	1 ms
		1 D-OUT	1 D-OUT	1
	3 SC sensors	1 I1	2	≥ 1 ms
		1 I2	2	≥ 1 ms
		1 I3	2	≥ 1 ms
	2 sensors without sensor-ID	2 I4/5	2	≥ 0.1 ms
	SR-HPM-6216-05-0C-CAN (Base unit + 2 model-01 input modules)	2 CAN-bus networks	8 CANX	16
8 CANY			16	≥ 1 ms
1 D-IN		1 D-IN	1	1 ms
		1 D-OUT	1 D-OUT	1
6 SC sensors		1 I1	2	≥ 1 ms
		1 I2	2	≥ 1 ms
		1 I3	2	≥ 1 ms
		1 I6	2	≥ 1 ms
		1 I7	2	≥ 1 ms
		1 I8	2	≥ 1 ms
4 sensors without sensor-ID		2 I4/5	2	≥ 0.1 ms
		2 I9/10	2	≥ 0.1 ms

## 13.2 Base instrument - inputs

### 13.2.1 CAN-bus (Intelligent digital)

Specification	Characteristics	Description
	Two CAN-bus networks	CAN = Controller Area Network CAN X, CAN Y
Plug	Five-pole, M12x1, integrated connector	Per network. SPEEDCON® connector version
Pin assignments	Pin 1 = Shield Pin 2 = CAN V+ Pin 3 = CAN GND Pin 4 = CAN High Pin 5 = CAN Low Housing = shield	CAN Standard
Supply voltage	+18 to +24 V DC	Per network
Power supply	Max. 500 mA	For both networks together
Fuse	short-circuit	Per network CAN V+ to GND
CAN X	Terminating resistor: 120 Ω between pins 4 and 5	No electrical isolation
CAN Y	Terminating resistor: 120 Ω between pins 4 and 5. Can be deactivated via software.	Electrical isolation between CAN_H and CAN_L, CAN V+ and CAN GND can be deactivated via software
CAN-bus baud rates	500 kBit	Other baud rates are possible
CANX network nodes	Max. 8	CANX1 – CANX8 for SCPT with P and T = 16 channels
CANY network nodes	Max. 8	CANY1 – CANY8 for SCPT with P and T = 16 channels
Polling rate for P-channel, 1	1 ms	Per network, with up to four sensors
Polling rate for P-channel, 2	2 ms (per network)	Per network, with up to five sensors

## Technical Specifications

### 13.2.2 Digital channels

Specification	Characteristics	Description
Plug	Four-pole, M8x1, integrated connector	One plug for D-IN/D-OUT
Pin assignments	Pin 1 = Digital IN + Pin 2 = Digital IN GND Pin 3 = Digital OUT + Pin 4 = Digital OUT GND	
Active High	+7 to +24 VDC	
Active Low	<1 VDC	
D-IN input impedance	1 k $\Omega$	
D-OUT output current	Max. 20 mA	

### 13.3 Interfaces on base instrument

#### 13.3.1 LAN

Specification	Characteristics	Description
Plug	RJ45, socket, shielded	
Transfer rate	10, 100 MBit/s	
Standard	IEEE 802.3 (10/100BaseT)	

#### 13.3.2 USB host

Specification	Characteristics	Description
Plug	USB socket, shielded, type A	
USB Standard	2.0, full speed	
Transfer rate	12 MBit/s	Memory size: Max. 40 GB
Power Supply	+5 V DC	
Power supply	Max. 100 mA	Low power
Fuse	short-circuit	VCC to GND

**13.3.3 USB device**

Specification	Characteristics	Description
Plug	USB socket, shielded, type B	
USB Standard	2.0, full speed	
Transfer rate	12 MBit/s	
Power supply to SCM-500	No	The USB connection does not serve as a power supply to the SCM-500.

**13.3.4 SD memory card**

Specification	Characteristics	Description
Slot	Micro SD memory card	Memory size: Max. 2 GB

## Technical Specifications

### 13.4 Basic instrument - additional components

#### 12.4.1 Memory

Specification	Measurement memory	External memory
Memory for running measurements	Volatile graphed data memory approx. 4,000,000 measured values	
Flash	Non-volatile total measured value memory approx. 32,000,000 measured values	
SD memory card	Over 1 billion measured values	Max. 2 GB
USB memory	Over 1 billion measured values	Max. 40 GB

#### 13.4.2 Display screen

Specification	Characteristics	Description
Type	Graphic, color TFT LCD, negative, transmissive	
Size	5.7 inch	
Visible surface	115 x 86 mm	
Resolution	640 x 480	VGA
Illumination	Backlit LED	10 levels

#### 13.4.3 Power supply (external)

Specification	Characteristics	Description
Plug	3-pole, socket	Binder brand, 719 series
Voltage	+11 to +30 V DC	
Current consumption	2000 mA (max.)	at 24 V DC
Rechargeable battery	Internal battery charging circuitry	
Recharging time	approx. 3 hours	at 24 V DC, 2500 mA



### 13.4.4 Power supply for battery

Specification	Characteristics	Description
Type	Lithium-ion battery	
Voltage	+7.4 V DC	
Capacity	4500 mAh	
Discharge time	Over 8 hours	with 6 sensors and 20 mA per sensor

### 13.4.5 General

Specification	Characteristics	Description
Housing material	ABS/PC	Thermoplastic
Material of protective sleeve around housing	TPE	Thermoplastic elastomer
Dimensions	257 × 74.5 × 181 mm	W x H x D
Weight	1550 g	Basic instrument
Acoustic signal	Buzzer	Event-driven activation, software

### 13.4.6 Input module slot

Specification	Characteristics	Description
Number	2	
Designation for inputs on slot 1	I1, I2, I3, I4/5	
Designation for inputs on slot 2	I6, I7, I8, I9/10	

## Technical Specifications

### 13.4.7 Ambient conditions

Specification	Characteristics	Description
Operating temperature	0 to +50 °C	
Storage temperature	-25 to +60 °C	
Temperature margin of error:	0.02 %/°C	
Relative humidity	<80 %	
Degree of protection	IP64	While plugged in (CAN, D-IN/OUT) and with plastic covers

### 13.4.8 Standards

Specification	Characteristics	Description
USB	USB 2.0	
LAN	IEEE 802.3	
CAN	EN 80325-4	
Disturbance emissions	EN61000-6-3 + FCC	
Resistance to interference	EN61000-6-2	
HF field	IEC61000-4-3	Min. 10 V/m, margin of error < 1 %
ESD	IEC61000-4-2	4/8 kV
High-frequency, conducted	IEC61000-4-6	10 kV
Burst	IEC61000-4-4	2 kV
Surge	IEC61000-4-5	1 kV symmetric on power supply 2 kV asymmetric on power supply
Drop test	IEC60068-2-32	1 metre free fall ED without plug
Degree of protection	EN60529	IP64

### 13.5 Input module, model 01

#### 13.5.1 Version

Specification	Characteristics	Description
Version	Model 01	
Inputs	Three SC sensors with sensor-ID Two sensor without sensor-ID	IN1, IN2, IN3 (IN6, IN7, IN8) IN4/5 (IN9/10)
Inputs per SC sensor	One faster channel One slower channel	1 ms, P-channel 1 second, T-channel
Inputs per sensor without sensor-ID	One faster channel One FAST channel	1 ms IN4/5 (IN9/10) 0.1 ms IN4 (IN9)

#### 13.5.2 SC sensor input for sensor with automatic sensor-ID

Specification	Characteristics	Description
Plug	5-pole, push-pull, size 1	
Input resistance	470 k $\Omega$	
Signal input for P-channel	-3.1 to +3.4 VDC	
Polling rate for P-channel	1 ms	
Filter for P-channel	500 Hz, low-pass	
Signal input for T-channel	0 to 3.1 VDC	
Polling rate for T-channel	1 second	
Filter for T-channel	7 Hz	
Resolution for P/T-channels	12-bit + sign	
Power supply, +Ub	+8 to 15 VDC	
Power supply, current	Max. 70 mA	per input (Ix)
Fuse	short-circuit	+Ub to GND

### 13.5.3 Sensors without sensor-ID (general)

Specification	Characteristics	Description
Plug	5-pole, M12x1, socket	
Pin assignments	Pin 1 = +Ub Pin 2 = Signal Pin 3 = GND Pin 4 = Signal Pin 5 = GND	I4 (I9) I5 (I10)
Signal	Current or voltage	Software switchable for each input I4/I5 (I9/I10)
Input resistance (current)	150 Ω	
Signal input (current)	0/4 to 20 mA	
Input resistance (voltage)	>100 kΩ	
Signal input (voltage)	-10 to +10 V DC	
Supply voltage	+18 to +24 V DC	
Power supply, current	Max. 100 mA	100 mA total for I4/I5 100 mA total for I9/I10
Fuse	short-circuit	+Ub to GND

### 13.5.4 Sensors without sensor-ID (sampling/polling)

Specification	Characteristics	Description
Polling rate types	1 ms, 0.1 ms	Software switchable
Polling rate: 1 ms	I4/5, I9/10	
Filter (1 ms)	500 Hz, low-pass	
Polling rate: 0.1 ms	I4, I9 (FAST channel)	If 0.1-ms polling rate, then I1-I3, I5, I6-I8, I10, CANX, CANY, D-IN/OUT are non-functional
Filter (0.1 ms)	5 kHz, low-pass	
Resolution	12-bit + sign	

**13.5.5 Input module (general)**

<b>Specification</b>	<b>Characteristics</b>	<b>Description</b>
Housing material	ABS/PC	Thermoplastic
Weight	75 g	
Measurement accuracy	< +/- 0.2% T-channel < +/- 0.25% FS	
Operating temperature	0 to +50 °C	
Storage temperature	-25 to +60 °C	
Temperature margin of error	0.02%/°C	
Rel. humidity	<80%	
Degree of protection	IP64 (IP54)	IP 64: When built into SMP and with plastic covers IP 54: While plugged in





For Sales & Service contact  
Auskunft & Beratung  
Contact Service commercial & maintenance  
Para más información sobre ventas y servicios contactar con

Distributor - Vertriebspartner - Distributeur - Distribuidor



St. Ives, Cambs, PE27 3LZ, UK  
Tel: +44 (0) 1480 397 400 - sales-uk@webtec.com

中国:

Tel: +86-21-61498441 - sales-cn@webtec.com

France

Tel: +33 (0) 3 27 82 94 56 - ventes-fr@webtec.com

Deutschland

Tel: +49 (0)231-9759-747 - vertrieb-de@webtec.com

U.S.A & Mexico

Tel: +1-800-932-8378 - sales-us@webtec.com

**www.webtec.com**



Certificate No.8242

Webtec reserve the right to make improvements and changes to the specification without notice.  
Webtec behält sich das Recht vor, Verbesserungen oder Änderungen der Spezifikationen ohne Ankündigung vorzunehmen.  
Webtec se réserve le droit d'améliorer et de changer ses spécifications sans préavis.  
Webtec se reserva el derecho de realizar mejoras y cambios a las especificaciones sin previo aviso.